



AESCLAP[®] STERILE CONTAINER SYSTEM

GENERAL CATALOG

OFTEN IMITATED. NEVER EQUALED THE AESCULAP ORIGINAL



Always better. From the beginning.

In 1971, Aesculap revolutionized the packaging and supply of sterile instruments with the world's first sterile container. From then up to the present day, the Aesculap original has become the universal solution and Aesculap is the global sterile container market leader.



AESFULAP® STERILE CONTAINER SYSTEM

LEADING GLOBAL SUPPLIER FOR DECADES

Aesculap, a leading manufacturer of sterile containers for over 50 years.



With the development and launch of the first real sterile container in 1971, Aesculap delivered a world first. Their innovative technology and their ease of handling have made AESFULAP® sterile containers a permanent fixture in hospitals worldwide. The use of AESFULAP® sterile containers means that the entire process can be standardized, controlled and documented: from storage to transport, through to the aseptic presentation of the sterile instruments in the operating room. Even at the disposal stage, the AESFULAP® sterile container system reliably protects users in health facilities from contamination.

The AESFULAP® sterile container system provides customers with an extensive and clinically proven product portfolio for sterile packaging.

Various sterile container models and sizes, as well as an extensive range of accessories, comprising different basket models, together with the proven Aesculap InOS® organization system enable reliable protection for almost all surgical instrument sets.





The right instruments
 at the right time
 in sterile, functional condition
 at the right place of use
 at a high level of profitability¹
 in a reliable packaging system



¹ Krohn M, Fengler J, Mickley T, Flessa S. Analysis of processes and costs of alternative packaging options of sterile goods in hospitals - a case study in two German hospitals. Health Economics Review (2019) 9:1

AESFULAP® STERILE CONTAINER SYSTEM

LEADING GLOBAL SUPPLIER FOR DECADES



Perforated soft packaging can have serious consequences ...



... focus more on stability with the AESCULAP® Sterile Container System.

¹ Krohn M, Fengler J, Mickley T, Flessa S. Analysis of processes and costs of alternative packaging options of sterile goods in hospitals – a case study in two German hospitals. Health Economics Review (2019) 9:1

² Waked WR, Simpson AK, Miller CP, Magit DP, Grauer JN. Sterilization wrap inspections do not adequately evaluate instrument sterility. Clin Ortop Relat Res. 2007; 462:207-211

AESFULAP® STERILE CONTAINER SYSTEM

QUALITY WITHOUT COMPROMISE – MADE IN GERMANY

Innovation Factory in Tuttlingen – Innovation meets tradition

The AESFULAP® sterile container system has been manufactured at the Tuttlingen/Germany site for more than 50 years. All the components of an AESFULAP® sterile container comply with the national and international requirements and standards (e.g. DIN EN ISO 11607-1). The solid, robust design* and the manufacturing technology used by Aesculap enable the sterile containers, instrument baskets and all the other components to be manufactured with very precise dimensions and a high level of stability.





With a modern industrial architecture, at the Innovation Factory, which was opened in June 2015, Aesculap acts on the B. Braun corporate values: be innovative, increase efficiency and live sustainably. The goal is an intelligent factory. This is characterized by adaptability, efficient use of resources and ergonomic design.

Think about tomorrow today!

The Innovation Factory meets the criteria for the German Sustainable Building Council (DGNB) silver certificate. Among other things, the factory has a fully automated

container production line with 10 processing stations, which are linked with seven robots, as well as a fully automated raw materials warehouse with approx. 600 storage areas.

The spacious premises with the latest equipment has space for around 500 employees. Production, development and product management are spatially linked to one another. This ensures a quick and constant exchange between all departments - the basis for a future-oriented finding and implementation of solutions.

* EN 868-8 (handle strength test, stacking test)

AESFULAP® STERILE CONTAINER SYSTEM

QUALITY WITHOUT COMPROMISE – MADE IN GERMANY

AESFULAP® sterile containers are tested based on the latest national and international standards.



EN ISO 11607-1
EN 868-8



Aesculap Technical Service



The AESCULAP® sterile containers protect sterile items against external influences and keep them sterile for when they are used. If they are damaged in any way (e.g. through deformation or wear), they can usually be repaired.

Original AESCULAP® container spare parts are compatible with all generations so the sterile containers will always be upgraded to the latest status quo by a repair. As a result, every repair by the Aesculap Technical Service helps retain the value of your sterile container stock.

Don't use damaged sterile containers! Please check your AESCULAP® sterile container before each use. Precise instructions can be found in the Aesculap instructions for use and on the Aesculap functional testing posters (please ask us about them if needed).

AESCULAP® STERILE CONTAINER SYSTEM

ONE SYSTEM, THREE OPTIONS – PRIMELine® PRO, BASIS, VARIO

High flexibility: As the bottoms are identical, you can choose between three different systems. Using existing AESCULAP® container bottoms helps reduce purchasing costs.



The extensive and well-proven Aesculap product portfolio for sterile instrument packaging offers a range of packaging solutions for all hospital instrument sets used in practice. Sterile containers in various models and sizes and the comprehensive range of accessories make the Sterile Container System a universal solution for the sterile supply of surgical instruments.

■ PRIMELine® PRO



■ BASIS



■ VARIO



■ PRIMELine® PRO

The PRIMELine® PRO aluminum container lid is equipped with Aesculap's proven permanent germ barrier system. This system consists of a cartridge with a well-protected, integrated PTFE (polytetrafluoroethylene) filter. This germ barrier has been validated for 5,000 sterilization cycles according to EN 868-8 (2009), Annex H and therefore commonly provides lifelong function (in everyday hospital use).

As a result, typically, no filter changes are necessary, thereby saving time and process costs. A cleaning validation has been carried out for the PRIMELine® Pro lid in an automated procedure. A positive cleaning result, suitable for everyday use in the hospital, was achieved*.

The cleaning result fully complied with the acceptance criteria.

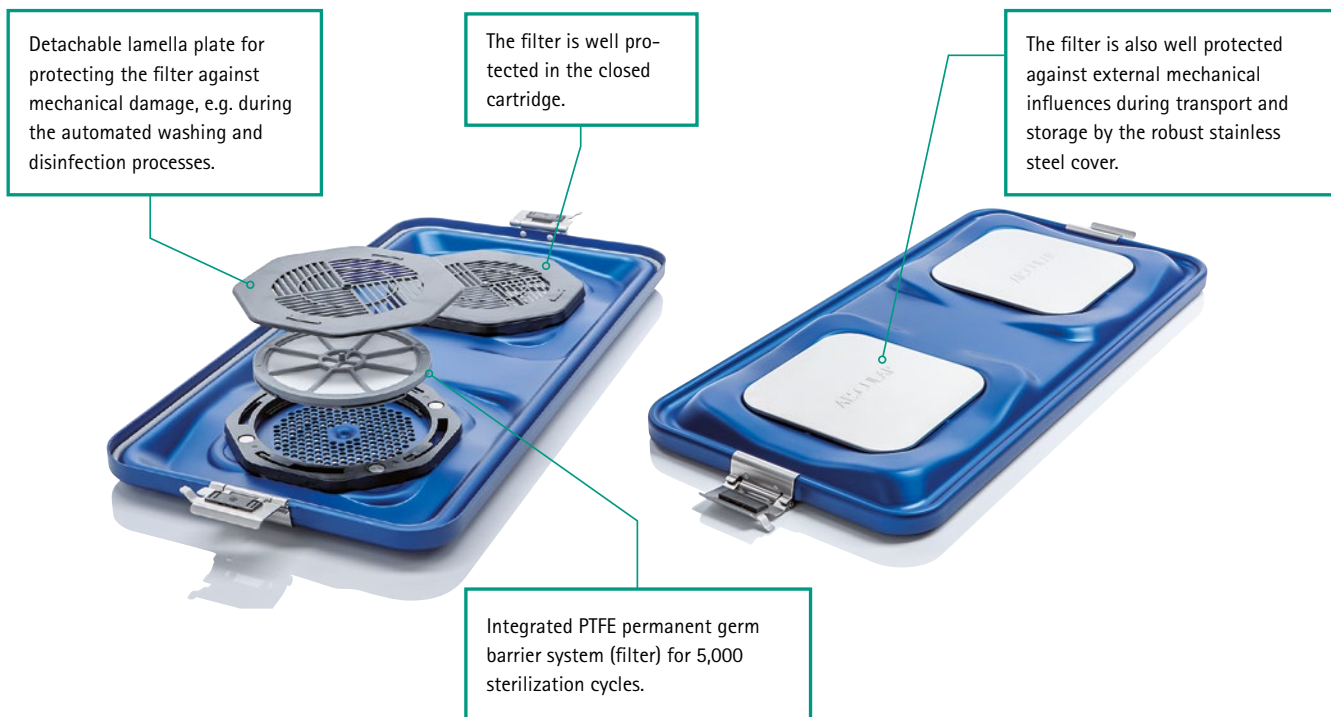

- Stable, robust aluminum lid
- Typically no filter change – saves time and process costs
- Cleaning validation fully complies with the acceptance criteria
- Available in 5 colors (red, blue, green, gold and silver)
- Compatible with all container bottoms (1/1, 1/2, 3/4) manufactured since 1988

* Please refer to the brochure PRIMELine® Pro Test Results C01702

AESFULAP® STERILE CONTAINER SYSTEM

ONE SYSTEM, THREE OPTIONS – PRIMELine® PRO, BASIS, VARIO

■ BASIS

The basic model made of aluminum for use with AESFULAP® single-use sterile filters or with AESFULAP® PTFE reusable filters for 1,000 sterilizations.

The Basis version can be fitted with a protective lid, if desired. However, the sterile container is still fully functional without a protective lid. The two lids can only be separated when the sterile container is opened for better cleaning. There is a push-button on the inside of the lid for this purpose.



■ VARIO

The Vario model is also for use with AESCULAP® single-use filters or reusable filters for 1,000 sterilization cycles and provides additional cover of the perforation field. Therefore, it is particularly suitable for transport over longer distances or externally. The Vario outer lid can be removed without opening the sterile barrier. This is particularly useful for

storage over extended periods (high dust load) before the sterile container is brought to the OR. As the Vario and Basis system lids have different locking mechanisms, they have different article numbers.



Both lids can be removed as a unit...



... or separately. This means the protective lid, which may be contaminated with dust particles, can be left outside the operating room. The sterile container remains sealed and its contents sterile.

AESCLAP® STERILE CONTAINER SYSTEM

AESCLAP® STERILE FILTERS

Different filters for different requirements



Aesculap PTFE (polytetrafluorethylene) permanent germ barrier system validated for 5,000 sterilization cycles according to EN 868-8, Annex H for lifelong function (in everyday hospital use). As a result, typically, no filter changes are necessary, saving time and process costs. For steam sterilization in a validated fractionated vacuum process according to EN ISO17665-1. Integrated into the PRIMELine® PRO sterile container lid.

AESCLAP® paper filter for single use. The filters for steam sterilization have an indicator according to EN ISO 11140-1 Type 1. Therefore, used and unused filters can be clearly differentiated visually. For use in Basis or Vario sterile container lids.



AESCLAP® reusable PTFE (polytetrafluorethylene) filters for 1,000 sterilization cycles (for steam sterilization in a fractionated vacuum process validated according to EN ISO17665-1). For use in Basis or Vario sterile container lids.

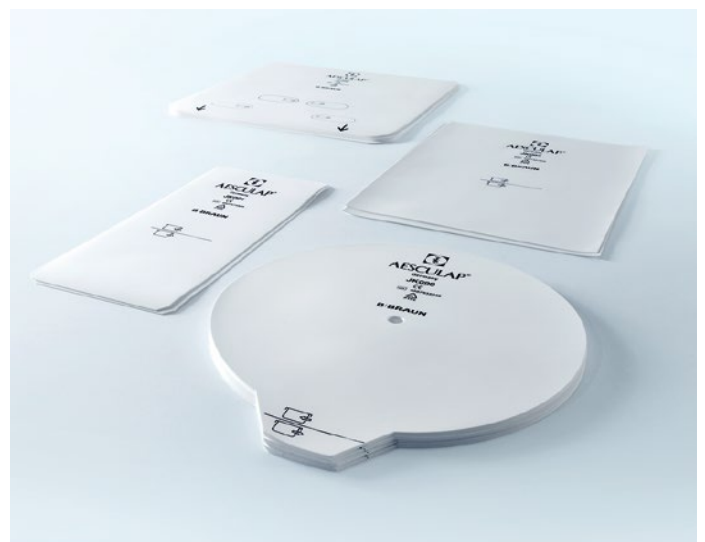

Paper filters and reusable filters are held firmly in the lid by the AESCULAP® filter retention plate (Basis and Vario). It has a silicone gasket and ensures that the filter is securely fitted. The retention plate has a safety lock (two release buttons) to prevent an uncontrolled release of the filter. It also enables quick filter changes. The audible click makes control easier.



Filter retention plate with safety lock

- Prevents uncontrolled release
- Quick filter change
- Audible click-in



AESFULAP® STERILE CONTAINER SYSTEM

QUICK, RELIABLE AND EFFICIENT

The AESFULAP® sterile container system in daily use

■ In the medical device reprocessing unit:

After cleaning and disinfection, a visual function check is performed and, if necessary, a new paper filter inserted.

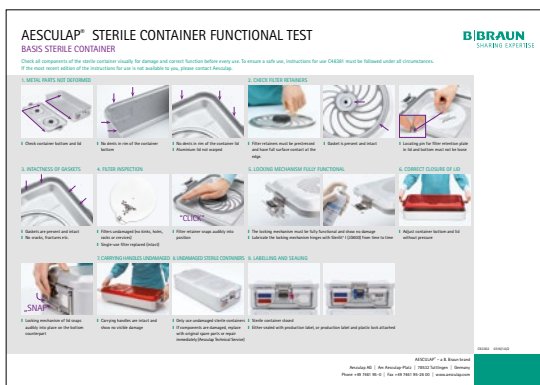

Next, the sterile container is then sealed on both sides. The production label is then affixed. The sterile container is now ready for sterilization.

The sterile container can be labeled using the color-coded labels, e.g. with information on the contents of the basket and/or where it belongs (neuro, OR 1, building A, etc.).

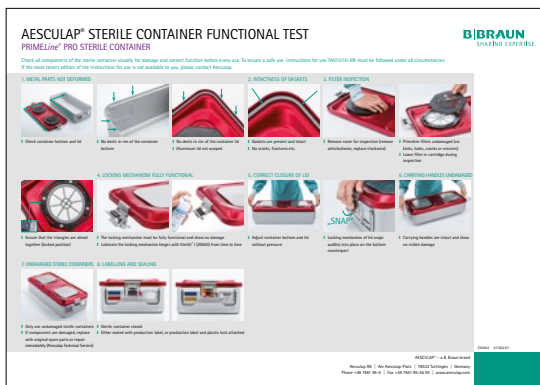

The packed instrument basket is then placed in the container bottom. The lid is then put on and locked.

Sterile container sealed with the AESFULAP® plastic seal with indicator¹.



Sterile container sealed with AESFULAP® indicator label¹.

¹ According to EN ISO 11140-1 Type 1

■ In the operating room

After sterilization and the corresponding cooling phase, the sterile containers are placed in the sterile instrument store. The instrument sets are now ready to be used again. The AESCULAP® sterile container storage period (up to 1 year) has been tested in several long-term studies. The tests proved that sterility was maintained throughout the entire period. The storage conditions used in the tests complied with ANSI/AAMI ST79².

The corresponding nursing staff bring the closed sterile containers to the operating room and check that the seals are intact and the indicator has changed. The sterile container is then opened. When it is opened, the container seals are destroyed by the locking flaps*. A nurse lifts the lid off and stands back. A check is then carried out to ensure that the filter and gasket are intact. The lid is then put down.

The surgical nurse picks the instrument set up in the sterile container and places it on the preparation table.



* Alternatively:
Break the seal
by hand.

² ANSI/AAMI ST79: Comprehensive Guide to Steam Sterilization and Sterility Assurance in Health Care Facilities

AESCLAP® STERILE CONTAINER SYSTEM

QUICK, RELIABLE AND EFFICIENT

WHICH STERILE CONTAINER IS SUITABLE FOR EACH STERILISATION PROCESS? – AN OVERVIEW

For all AESCLAP® sterile containers with CE marking.

		Steam sterilization ¹		Low temperature processes		
		Fractionated vacuum process	Gravity process	Sterrad® 100S, 200, NX, 100NX	Steris® Amsco V-Pro 1, V-Pro 1 Plus	Eto ²
Sterile containers	Basis	JK Series ✓	JN Series ✓	Incompatible	Incompatible	Not validated
	Vario	JK Series ✓	JN Series ✓	Incompatible	Incompatible	Not validated
	PRIMELine® PRO	JK Series ✓	Not validated	Incompatible	Incompatible	Incompatible
	Scope containers	✓	Not validated	JM020+JM021 ✓	JM020+JM021 ✓	✓
	Mini containers	JK Series ✓	JN Series ✓	JM188+JM174 ✓	JM188+JM174 ✓	Not validated
	Dental containers	JK Series ✓	JN Series ³ ✓	Incompatible	Incompatible	Not validated
	XXL EndoContainer	JK Series ✓	JN Series ✓	Incompatible	Incompatible	Not validated
Filters	Paper - for single use	✓	✓	Incompatible	Incompatible	✓
	PTFE - reusable	✓	✓	Incompatible	Incompatible	Not validated
	Polypropylene - for single use (JF167)	Not validated	Not validated	✓	✓	Not validated

	OK (sometimes only with certain article numbers - see note)
	Not validated
	Incompatible

¹ The sterilization must be done in a steam sterilization process validated according to ISO 17665-1 in a sterilizer according to EN 285.

² The sterilization must be validated according to EN 550/ISO 11135-1.

³ Except JN292, JN294, JN295, JN296 - these are for the fractionated vacuum process only.

Aesculap Academy
 DIALOG – DEDICATED TO LIFE.



Training events at the Aesculap Academy, contributions from Aesculap staff at national and international conferences, and above all extensive consultancy activities with users themselves – this is our contribution to the continuous improvement of sterile product supply worldwide.

At the same time, we are continuously improving AESCULAP® sterile containers, always in dialog with our customers so that we can provide them with reliable solutions in the future as well. This knowledge exchange is at the heart of our business.



VISION – MISSION – COMMITMENT

- **Our VISION:** We set sustainable standards for the benefit of patients and to preserve our environment for future generations.
- **Our MISSION:** The AESCULAP® Sterile Container System provides the right instrument, in a sterile condition and with low process costs, at the right time in the operating room.
- **Our COMMITMENT:** We have been in dialog with our customers for more than 50 years in order to provide them with reliable solutions. This dialog will be at the heart of our business in the future as well.



Tuttlingen | Berlin | Bochum

STERILE CONTAINERS



PRIMELine® PRO

SIZE 1/1

Lids for individual color combination





	Color
JP101	red
JP102	blue
JP103	green
JP104	gold
JP105	silver



	JK440
	JK441
	JK442
	JK444
	JK446

Solid bottoms = JK

TABLES OF DIMENSIONS PRIME*Line*[®] PRO SIZE 1/1

Bottom 1/1		Lid		Sterile container with lid	
	Outside dimensions		Outside dimensions		Outside dimensions Inside dimensions
JK440	592 x 274 x 90	JP101 - JP105	588 x 281 x 36		592 x 281 x 107 544 x 258 x 75
JK441	592 x 274 x 120				592 x 281 x 137 544 x 258 x 105
JK442	592 x 274 x 135				592 x 281 x 152 544 x 258 x 120
JK444	592 x 274 x 187				592 x 281 x 204 544 x 258 x 172
JK446	592 x 274 x 247				592 x 281 x 264 544 x 258 x 232

PRIMELine® PRO

SIZE 3/4

Lids for individual color combination



	Color
JP111	red
JP112	blue
JP113	green
JP114	gold
JP115	silver



	JK740
	JK741
	JK742
	JK744

Solid Bottoms = JK

TABLES OF DIMENSIONS PRIME*Line*[®] PRO SIZE 3/4

Bottom 3/4		Lid		Sterile container with lid	
	Outside dim.		Outside dim.		
JK740	470 x 274 x 90	JP111 - JP115	465 x 281 x 36	Outside dimensions	
				Inside dimensions	
JK741	470 x 274 x 120			470 x 281 x 107	421 x 258 x 75
JK742	470 x 274 x 135			470 x 281 x 137	421 x 258 x 105
JK744	470 x 274 x 187			470 x 281 x 152	421 x 258 x 120
				470 x 281 x 204	421 x 258 x 172

PRIMELine® PRO

SIZE 1/2

Lids for individual color combination



for JK339	for JK340-JK346	Color
JP131	JP121	red
JP132	JP122	blue
JP133	JP123	green
JP134	JP124	gold
JP135	JP125	silver



	JK339 without carrying handle
	JK340
	JK341
	JK342
	JK344
	JK346

Solid bottoms = JK

TABLES OF DIMENSIONS PRIME*Line*[®] PRO SIZE 1/2

Bottom 1/2		Lid		Sterile container with lid	
	Outside dimensions		Outside dimensions		Outside dimensions Inside dimensions
JK339 without carrying handle	300 x 274 x 57	JP131 - JP135	298 x 281 x 36		300 x 281 x 74 260 x 265 x 35
JK340	300 x 274 x 90	JP121 - JP125	298 x 281 x 36		300 x 281 x 107 254 x 258 x 75
JK341	300 x 274 x 120				300 x 281 x 137 254 x 258 x 105
JK342	300 x 274 x 135				300 x 281 x 152 254 x 258 x 120
JK344	300 x 274 x 187				300 x 281 x 204 254 x 258 x 172
JK346	300 x 274 x 247				300 x 281 x 264 254 x 258 x 232

BASIS

SIZE 1/1

Lids for individual color combination

Inner lid

	Color
JK485	red
JK486	blue
JK487	green
JK488	gold
JK489	silver

Outer lid

	Color
JK475A	red
JK476A	blue
JK477A	green
JK478A	gold
JK479A	silver



		
	JK440	JN440
	JK441	JN441
	JK442	JN442
	JK444	JN444
	JK446	JN446

Solid bottoms = JK





Perforated bottoms = JN







JF101R support for trays

TABLES OF DIMENSIONS BASIS

SIZE 1/1

Bottom 1/1		Inner lid		Outer lid		Sterile container with inner lid		Sterile container with inner and outer lid	
	Outside dim.		Outside dim.		Outside dim.		Outside dim. Inside dim.		Outside dim. Inside dim.
JK440	592 x 274 x 90	JK485 - JK489	588 x 285 x 36	JK475A - JK479A	588 x 291 x 36	592 x 285 x 108 544 x 258 x 75	592 x 291 x 115 544 x 258 x 75		
JK441	592 x 274 x 120					592 x 285 x 138 544 x 258 x 105	592 x 291 x 145 544 x 258 x 105		
JK442	592 x 274 x 135					592 x 285 x 153 544 x 258 x 120	592 x 291 x 160 544 x 258 x 120		
JK444	592 x 274 x 187					592 x 285 x 205 544 x 258 x 172	592 x 291 x 212 544 x 258 x 172		
JK446	592 x 274 x 247					592 x 285 x 265 544 x 258 x 232	592 x 291 x 272 544 x 258 x 232		

Bottom 1/1		Inner lid		Outer lid		Sterile container with inner lid		Sterile container with inner and outer lid	
	Outside dim.		Outside dim.		Outside dim.		Outside dim. Inside dim.		Outside dim. Inside dim.
JN440	592 x 274 x 90	JK485 - JK489	588 x 285 x 36	JK475A - JK479A	588 x 291 x 36	592 x 285 x 108 544 x 258 x 63	592 x 291 x 115 544 x 258 x 63		
JN441	592 x 274 x 120					592 x 285 x 138 544 x 258 x 93	592 x 291 x 145 544 x 258 x 93		
JN442	592 x 274 x 135					592 x 285 x 153 544 x 258 x 108	592 x 291 x 160 544 x 258 x 108		
JN444	592 x 274 x 187					592 x 285 x 205 544 x 258 x 160	592 x 291 x 212 544 x 258 x 160		
JN446	592 x 274 x 247					592 x 285 x 265 544 x 258 x 220	592 x 291 x 272 544 x 258 x 220		

BASIS

SIZE 3/4

Lids for individual color combination

Inner lid

	Color
JK785	red
JK786	blue
JK787	green
JK788	gold
JK789	silver

Outer lid

	Color
JK775A	red
JK776A	blue
JK777A	green
JK778A	gold
JK779A	silver



		
	JK740	JN740
	JK741	JN741
	JK742	JN742
	JK744	JN744

Solid bottoms = JK





Perforated bottoms = JN







JF104R support for trays

TABLES OF DIMENSIONS BASIS

SIZE 3/4

Bottom 3/4		Inner lid		Outer lid		Sterile container with inner lid		Sterile container with inner and outer lid	
	Outside dim.		Outside dim.		Outside dim.		Outside dim. Inside dim.		Outside dim. Inside dim.
JK740	470 x 274 x 90	JK785 - JK789	460 x 285 x 36	JK775A - JK779A	460 x 291 x 36	470 x 285 x 108 421 x 258 x 75	470 x 291 x 115 421 x 258 x 75		
JK741	470 x 274 x 120					470 x 285 x 138 421 x 258 x 105	470 x 291 x 145 421 x 258 x 105		
JK742	470 x 274 x 135					470 x 285 x 153 421 x 258 x 120	470 x 291 x 160 421 x 258 x 120		
JK744	470 x 274 x 187					470 x 285 x 205 421 x 258 x 172	470 x 291 x 212 421 x 258 x 172		

Bottom 3/4		Inner lid		Outer lid		Sterile container with inner lid		Sterile container with inner and outer lid	
	Outside dim.		Outside dim.		Outside dim.		Outside dim. Inside dim.		Outside dim. Inside dim.
JN740	470 x 274 x 90	JK785 - JK789	460 x 285 x 36	JK775A - JK779A	460 x 291 x 36	470 x 285 x 108 421 x 258 x 63	470 x 291 x 115 421 x 258 x 63		
JN741	470 x 274 x 120					470 x 285 x 138 421 x 258 x 93	470 x 291 x 145 421 x 258 x 93		
JN742	470 x 274 x 135					470 x 285 x 153 421 x 258 x 108	470 x 291 x 160 421 x 258 x 108		
JN744	470 x 274 x 187					470 x 285 x 205 421 x 258 x 160	470 x 291 x 212 421 x 258 x 160		







BASIS

SIZE 1/2

Lids for individual color combination

Inner lid

Outer lid

for JK339	for JK340-JK346	Color	for JK339-JK346	Color			
JK395	JK385	red	JK375A	red		JK339 without carrying handle	-
JK396	JK386	blue	JK376A	blue		JK340	JN340
JK397	JK387	green	JK377A	green		JK341	JN341
JK398	JK388	gold	JK378A	gold		JK342	JN342
JK399	JK389	silver	JK379A	silver		JK344	JN344
						JK346	JN346



Solid bottoms = JK





Perforated bottoms = JN







JF102R support for trays

TABLES OF DIMENSIONS BASIS

SIZE 1/2

Bottom 1/2		Inner lid		Outer lid		Sterile container with inner lid		Sterile container with inner and outer lid	
	Outside dim.		Outside dim.		Outside dim.		Outside dim. Inside dim.		Outside dim. Inside dim.
JK339	300 x 274 x 57 <i>without</i> carrying handle	JK395 - JK399	298 x 285 x 36	JK375A - JK379A	298 x 291 x 36	300 x 285 x 67 260 x 265 x 35	300 x 291 x 75 260 x 265 x 35		
JK340	300 x 274 x 90	JK385 - JK389	298 x 285 x 36	JK375A - JK379A	298 x 291 x 36	300 x 285 x 108 254 x 258 x 75	300 x 291 x 115 254 x 258 x 75		
JK341	300 x 274 x 120					300 x 285 x 138 254 x 258 x 105	300 x 291 x 145 254 x 258 x 105		
JK342	300 x 274 x 135					300 x 285 x 153 254 x 258 x 120	300 x 291 x 160 254 x 258 x 120		
JK344	300 x 274 x 187					300 x 285 x 205 254 x 258 x 172	300 x 291 x 212 254 x 258 x 172		
JK346	300 x 274 x 247					300 x 285 x 265 254 x 258 x 232	300 x 291 x 272 254 x 258 x 232		

Bottom 1/2		Inner lid		Outer lid		Sterile container with inner lid		Sterile container with inner and outer lid	
	Outside dim.		Outside dim.		Outside dim.		Outside dim. Inside dim.		Outside dim. Inside dim.
JN340	300 x 274 x 90	JK385 - JK389	298 x 285 x 36	JK375A - JK379A	298 x 291 x 36	300 x 285 x 108 254 x 258 x 63	300 x 291 x 115 254 x 258 x 63		
JN341	300 x 274 x 120					300 x 285 x 138 254 x 258 x 93	300 x 291 x 145 254 x 258 x 93		
JN342	300 x 274 x 135					300 x 285 x 153 254 x 258 x 108	300 x 291 x 160 254 x 258 x 108		
JN344	300 x 274 x 187					300 x 285 x 205 254 x 258 x 160	300 x 291 x 212 254 x 258 x 160		
JN346	300 x 274 x 247					300 x 285 x 265 254 x 258 x 220	300 x 291 x 272 254 x 258 x 220		

VARIO SIZE 1/1

Lids for individual color combination

Inner lid



JK469 silver

Outer lid



JK455A red

JK456A blue

JK457A green

JK458A gold

JK459A silver



JK440 JN440



JK441 JN441



JK442 JN442



JK444 JN444



JK446 JN446

Solid bottoms = JK







Perforated bottoms = JN







JF101R support for trays

TABLES OF DIMENSIONS VARIO

SIZE 1/1

Bottom 1/1		Inner lid		Outer lid		Sterile container with inner lid		Sterile container with inner and outer lid	
	Outside dim.		Outside dim.		Outside dim.		Outside dim. Inside dim.		Outside dim. Inside dim.
JK440	592 x 274 x 90	JK469	588 x 285 x 36	JK455A - JK459A	582 x 291 x 36	592 x 285 x 108 544 x 258 x 75	592 x 291 x 115 544 x 258 x 75		
JK441	592 x 274 x 120					592 x 285 x 138 544 x 258 x 105	592 x 291 x 145 544 x 258 x 105		
JK442	592 x 274 x 135					592 x 285 x 153 544 x 258 x 120	592 x 291 x 160 544 x 258 x 120		
JK444	592 x 274 x 187					592 x 285 x 205 544 x 258 x 172	592 x 291 x 212 544 x 258 x 172		
JK446	592 x 274 x 247					592 x 285 x 265 544 x 258 x 232	592 x 291 x 272 544 x 258 x 232		

Bottom 1/1		Inner lid		Outer lid		Sterile container with inner lid		Sterile container with inner and outer lid	
	Outside dim.		Outside dim.		Outside dim.		Outside dim. Inside dim.		Outside dim. Inside dim.
JN440	592 x 274 x 90	JK469	588 x 285 x 36	JK455A - JK459A	582 x 291 x 36	592 x 285 x 108 544 x 258 x 63	592 x 291 x 115 544 x 258 x 63		
JN441	592 x 274 x 120					592 x 285 x 138 544 x 258 x 93	592 x 291 x 145 544 x 258 x 93		
JN442	592 x 274 x 135					592 x 285 x 153 544 x 258 x 108	592 x 291 x 160 544 x 258 x 108		
JN444	592 x 274 x 187					592 x 285 x 205 544 x 258 x 160	592 x 291 x 212 544 x 258 x 160		
JN446	592 x 274 x 247					592 x 285 x 265 544 x 258 x 220	592 x 291 x 272 544 x 258 x 220		

VARIO

SIZE 3/4

Lids for individual color combination

Inner lid



JK769 silver

Outer lid



JK755A red

JK756A blue

JK757A green

JK758A gold

JK759A silver



JK740 JN740



JK741 JN741



JK742 JN742



JK744 JN744

Solid bottoms = JK













Perforated bottoms = JN















JF104R support for trays

TABLES OF DIMENSIONS VARIO

SIZE 3/4

Bottom 3/4		Inner lid		Outer lid		Sterile container with inner lid		Sterile container with inner and outer lid	
	Outside dim.		Outside dim.		Outside dim.		Outside dim. Inside dim.		Outside dim. Inside dim.
JK740	470 x 274 x 90	JK769	460 x 285 x 36	JK755A - JK759A	460 x 291 x 36		470 x 285 x 108 421 x 258 x 75		470 x 291 x 115 421 x 258 x 75
JK741	470 x 274 x 120						470 x 285 x 138 421 x 258 x 105		470 x 291 x 145 421 x 258 x 105
JK742	470 x 274 x 135						470 x 285 x 153 421 x 258 x 120		470 x 291 x 160 421 x 258 x 120
JK744	470 x 274 x 187						470 x 285 x 205 421 x 258 x 172		470 x 291 x 212 421 x 258 x 172

Bottom 3/4		Inner lid		Outer lid		Sterile container with inner lid		Sterile container with inner and outer lid	
	Outside dim.		Outside dim.		Outside dim.		Outside dim. Inside dim.		Outside dim. Inside dim.
JN740	470 x 274 x 90	JK769	460 x 285 x 36	JK755A - JK759A	460 x 291 x 36		470 x 285 x 108 421 x 258 x 63		470 x 291 x 115 421 x 258 x 63
JN741	470 x 274 x 120						470 x 285 x 138 421 x 258 x 93		470 x 291 x 145 421 x 258 x 93
JN742	470 x 274 x 135						470 x 285 x 153 421 x 258 x 108		470 x 291 x 160 421 x 258 x 108
JN744	470 x 274 x 187						470 x 285 x 205 421 x 258 x 160		470 x 291 x 212 421 x 258 x 160

VARIO

SIZE 1/2

Lids for individual color combination

Inner lid

Outer lid

for JK339	for JK340-JK346	Color	for JK339-JK346	Color			
JK368	JK369	silver	JK355A	red		JK339 without carrying handle	-
			JK356A	blue		JK340	JN340
			JK357A	green		JK341	JN341
			JK358A	gold		JK342	JN342
			JK359A	silver		JK344	JN344
						JK346	JN346



Solid bottoms = JK





Perforated bottoms = JN







JF102R support for trays

TABLES OF DIMENSIONS VARIO

SIZE 1/2

Bottom 1/2		Inner lid		Outer lid		Sterile container with inner lid		Sterile container with inner and outer lid	
	Outside dim.		Outside dim.		Outside dim.		Outside dim. Inside dim.		Outside dim. Inside dim.
JK339	300 x 274 x 57 without carrying handle	JK368	298 x 285 x 36	JK355A- JK359A	298 x 291 x 36	300 x 285 x 67 260 x 265 x 35	300 x 291 x 75 260 x 265 x 35		
JK340	300 x 274 x 90	JK369	298 x 285 x 36	JK355A- JK359A	298 x 291 x 36	300 x 285 x 108 254 x 258 x 75	300 x 291 x 115 254 x 258 x 75		
JK341	300 x 274 x 120					300 x 285 x 138 254 x 258 x 105	300 x 291 x 145 254 x 258 x 105		
JK342	300 x 274 x 135					300 x 285 x 153 254 x 258 x 120	300 x 291 x 160 254 x 258 x 120		
JK344	300 x 274 x 187					300 x 285 x 205 254 x 258 x 172	300 x 291 x 212 254 x 258 x 172		
JK346	300 x 274 x 247					300 x 285 x 265 254 x 258 x 232	300 x 291 x 272 254 x 258 x 232		

Bottom 1/2		Inner lid		Outer lid		Sterile container with inner lid		Sterile container with inner and outer lid	
	Outside dim.		Outside dim.		Outside dim.		Outside dim. Inside dim.		Outside dim. Inside dim.
JN340	300 x 274 x 90	JK369	298 x 285 x 36	JK355A- JK359A	298 x 291 x 36	300 x 285 x 108 254 x 258 x 63	300 x 291 x 115 254 x 258 x 63		
JN341	300 x 274 x 120					300 x 285 x 138 254 x 258 x 93	300 x 291 x 145 254 x 258 x 93		
JN342	300 x 274 x 135					300 x 285 x 153 254 x 258 x 108	300 x 291 x 160 254 x 258 x 108		
JN344	300 x 274 x 187					300 x 285 x 205 254 x 258 x 160	300 x 291 x 212 254 x 258 x 160		
JN346	300 x 274 x 247					300 x 285 x 265 254 x 258 x 220	300 x 291 x 272 254 x 258 x 220		

MINI STERILE CONTAINERS

MINI STERILE CONTAINERS FOR SMALL SETS AND SMALL INSTRUMENTS.

The mini sterile containers were developed for small sets (e.g. small-wound treatment) and small, delicate instruments especially for microsurgery.

Suitable sterilisation processes (please also refer to page 20):

- Mini sterile containers are suitable for steam sterilisation using the fractionated vacuum process (solid bottom) and using the gravity process (perforated bottom).
- Separately labeled mini sterile containers (please also refer to the next page) are additionally suitable for low-temperature sterilisation processes with hydrogen peroxide in a Sterrad® 100 S, Sterrad® 200, Sterrad® NX, Sterrad® 100 NX, Steris V-Pro® 1 and Steris V-Pro® 1 Plus.
- Mini sterile containers are not suitable for hot air sterilization!

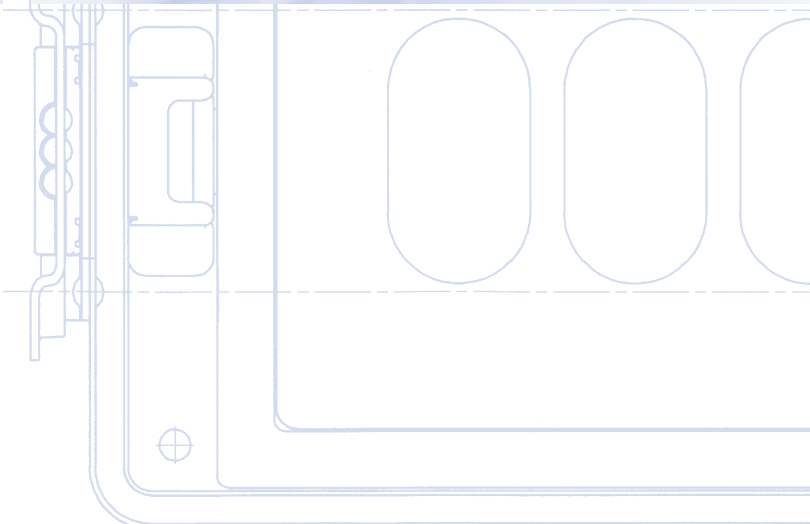
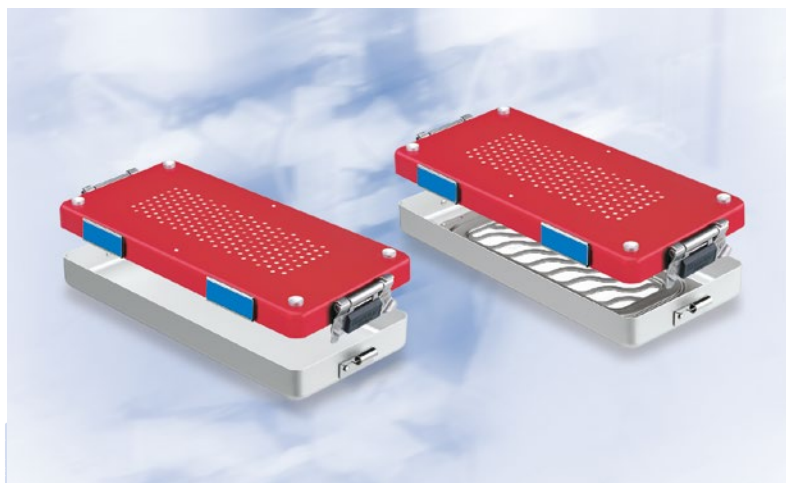

MINI STERILE CONTAINERS

Solid bottom = JK





Perforated bottom = JN



Lids for individual color combination



		Outside dimensions Length x Width x Height (mm)
JK187	JN187	310 x 132 x 30
JK188	JN188	310 x 132 x 57
	JM188*	310 x 132 x 57

	Color	Outside dimensions Length x Width x Height (mm)
JK170	red	305 x 140 x 25
JK171	blue	305 x 140 x 25
JK172	green	305 x 140 x 25
JK173	gold	305 x 140 x 25
JK174	silver	305 x 140 x 25
JM174*	silver	305 x 140 x 25

DIMENSIONS COMPLETE - Length x Width x Height (mm)

	Sterile containers, complete  Outside dimensions Inside dimensions
Bottom	with Lid
JK187	310 x 140 x 40 274 x 126 x 21
JK188	310 x 140 x 67 274 x 126 x 48

	Sterile containers, complete  Outside dimensions Inside dimensions
Bottom	with Lid
JN187	310 x 140 x 40 274 x 126 x 18
JN188	310 x 140 x 67 274 x 126 x 45
JM188*	310 x 140 x 67 274 x 126 x 45

* For low-temperature sterilisation processes with hydrogen peroxide in a Sterrad® 100 S, Sterrad® 200, Sterrad® NX, Sterrad® 100 NX, Steris V-Pro® 1 and Steris V-Pro® 1 Plus. To be used with disposable filter JF167 (see page 101).

DENTAL STERILE CONTAINERS

DENTAL STERILE CONTAINERS - THE SPECIAL DESIGN NOT ONLY FOR DENTAL SURGERY





AESFULAP® dental sterile containers are particularly suitable for sterile preparation in dental surgeries. The Dental Sterile Container fits into common small sterilizers. A wide range of accessories is available for combining individual instrument sets.







- The well-established locking levers facilitate the aseptic presentation
- Sterile containers can be stacked for space-saving in the sterile supplies cycle.
- Quick-release filter retention plate for quick and easy replacement of AESFULAP® sterile filters.
- System-designed trays for processing, thermal disinfection, sterilization, transport and storage of instruments.
- Suitable sterilisation processes (please also refer to page 20): Dental sterile containers are suitable for steam sterilisation using the fractionated vacuum process (solid bottom) and using the gravity process (perforated bottom). Dental sterile containers are not suitable for hot air sterilization!

NOTE: This sterile container can be ordered complete (lid and body) under one article number.

Solid bottom

	Outside dim. Inside dim.		Outside dim.		Color	Outside dim.
	JN292 312 x 190 x 46 277 x 176 x 27	JK286	312 x 185 x 37	JN091	silver	319 x 190 x 25
	JN294 312 x 190 x 65 277 x 176 x 46	JK288	312 x 185 x 56			
	JN295 312 x 190 x 92 277 x 176 x 73	JK289	312 x 185 x 83			
	JN296 312 x 190 x 130 277 x 176 x 111	JK290	312 x 185 x 121			

Perforated bottom

	Outside dim. Inside dim.		Outside dim.		Color	Outside dim.
	JN092 312 x 190 x 46 277 x 176 x 20	JN086	312 x 185 x 37	JN091	silver	319 x 190 x 25
	JN094 312 x 190 x 65 277 x 176 x 39	JN088	312 x 185 x 56			
	JN095 312 x 190 x 92 277 x 176 x 66	JN089	312 x 185 x 83			
	JN096 312 x 190 x 130 277 x 176 x 104	JN090	312 x 185 x 121			

STERILE CONTAINERS FOR SCOPES

SEPARATE STORAGE AND PROVISION OF THE SCOPES

- Separate, quick aseptic supply, independent of instrument sets
- Protection of sensitive scopes including light conducting cable during reprocessing, transportation and storage
- Individual design with the organisation system Aesculap InOS®
- Protected perforation field
- The handle on the tray lid allows simple aseptic removal
- Stackable
- Suitable sterilisation processes (please also refer to page 20):
The scope sterile container is suitable for steam sterilisation using the fractionated vacuum process. Separately labeled scope sterile containers (please also refer to the next page) are additionally suitable for low-temperature sterilisation processes with hydrogen peroxide in a Sterrad® 100 S, Sterrad® 200, Sterrad® NX, Sterrad® 100 NX, Steris V-Pro® 1 and Steris V-Pro® 1 Plus. The scope container is not suitable for using in gravity processes!



Note

Sterrad® 100 S, Sterrad® 200, Sterrad® NX and Sterrad® 100 NX are registered trademarks of ASP. V-Pro® 1 and V-Pro® 1 Plus are registered trademarks of Steris.

SCOPE STERILE CONTAINERS

LID

For the fractionated vacuum process
(incl. filter retention plate JK098)





	Outside dimensions Length x Width x Height (mm)
JK020	540 x 152 x 28

BOTTOM

For the fractionated vacuum process
(incl. filter retention plate JK098)



	Outside dimensions Length x Width x Height (mm)
JN021	540 x 144 x 65

Sterile container, complete	
	Outside dimensions
	Inside dimensions
	540 x 152 x 84
	503 x 134 x 45

AESCULAP® reusable filter for steam sterilisation, for use with filter retention plate JK098, service life 1,000 cleaning and sterilisation cycles.

Order unit (PAK): Pack of 2



	Outside dimensions Length x Width (mm)
JK091	95 x 215

AESCULAP® disposable filter for steam sterilisation with process indicator, for use with filter retention plate JK098.

Order unit (PAK): Pack of 100



	Outside dimensions Length x Width (mm)
JF166	118 x 235

TRAY

For up to two laparoscopic scopes and one light cable.

Preconfigured trays see page 61



	Outside dimensions Length x Width x Height (mm)
JF435R	501 x 134 x 45

Identification label with adhesive back and process indicator* for steam sterilisation and sterilisation with ethylene oxide.

Order unit (PAK): Pack of 100



	Outside dimensions Length x Width (mm)
JG751	67 x 35

LID

For the hydrogen peroxide sterilisation in Sterrad® 100 S, Sterrad® 200, Sterrad® NX, Sterrad® 100 NX, Steris V-Pro® 1 and Steris V-Pro® 1 Plus, (incl. filter retention plate JK098)



	Outside dimensions Length x Width x Height (mm)
JM020	540 x 152 x 28

BOTTOM

For the hydrogen peroxide sterilisation in Sterrad® 100 S, Sterrad® 200, Sterrad® NX, Sterrad® 100 NX, Steris V-Pro® 1 and Steris V-Pro® 1 Plus, (incl. filter retention plate JK098)



	Outside dimensions Length x Width x Height (mm)
JM021	540 x 144 x 65

Sterile container, complete

Outside dimensions
Inside dimensions

540 x 152 x 84
503 x 134 x 45

Disposable filter for the hydrogen peroxide sterilisation in Sterrad® 100 S, Sterrad® 200, Sterrad® NX, Sterrad® 100 NX, Steris V-Pro® 1 and Steris V-Pro® 1 Plus.

Order unit (PAK): Pack of 100



	Outside dimensions Length x Width (mm)
JF167	235 x 118

Universal filter retention plate



	Outside dimensions Length x Width x Height (mm)
JK098	245 x 100 x 6

Identification label with adhesive back and process indicator* for vaporized hydrogen peroxide sterilisation.

Order unit (PAK): Pack of 100



	Outside dimensions Length x Width (mm)
JG750	67 x 35

* acc. to EN ISO 11140-1 Type 1

XXL ENDO STERILE CONTAINER AND ACCESSORIES

- Extra long Sterile Container for endoscopic instruments with sheath length of up to 420 mm.
- The instruments can be sterilized as fully assembled units, if applicable.
- Suitable sterilisation processes (please also refer to page 20):
The XXL Endo Sterile Container is suitable for steam sterilisation using the fractionated vacuum process (solid bottom) and using the gravity process (perforated bottom).
- **Caution:** The Endo Sterile Container can be sterilized only in sterilizers of an appropriate chamber size (at least 720 mm effective depth).



BOTTOM

solid bottom = JK
perforated bottom = JN

		Outside dimensions Length x Width x Height (mm)		Outside dimensions Length x Width x Height (mm)
JK443	JN443	711 x 274 x 120	JK490	708 x 280 x 35
	JN445	711 x 274 x 187		

LID

Dimensions complete -
Length x Width x Height (mm)

	Sterile container, complete
	Outside dimensions Inside dimensions
JK443	711 x 285 x 138 667 x 258 x 105
JN443	711 x 285 x 138 667 x 258 x 93
JN445	711 x 285 x 205 667 x 258 x 160

BASKETS



	Outside dim. Inside dim.
JF232R	660 x 253 x 56 658 x 251 x 42
JF236R	660 x 253 x 86 658 x 251 x 72

SILICONE POSITIONING MAT FOR STORING OF ACCESSORIES

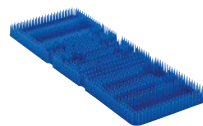

	Outside dim.
JF933	610 x 230 x 30

ENDORACK FITTING FOR JN445
Storage rack for MIS-instruments, XXL comprising: storage rack, XXL, perforated tray and silicone mat for instruments with shaft length up to 420 mm, fitting for JN445 + JK490

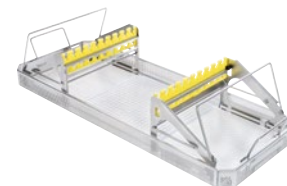

	Outside dim.
PL961R	660 x 253 x 166



DISPOSAL CONTAINERS

Disposal containers complete the instrument cycle. The closed containers protect both staff and the environment from contamination during the transport of used instruments.

The disposal containers are of the same dimensions as the standard sterile containers, thus allowing standardized and automated instrument return and transport.

As all components of the disposal containers are made of stainless steel, combined cleaning and disinfecting agents can be used in them, and they can be cleaned with alkaline detergents.



Container SIZE	Solid bottom		Lid with opening		Lid without opening		Container, complete  Outside dim. Inside dim.
		Outside dim.		Outside dim.		Outside dim.	
1/2	JK060R	295 x 275 x 90	JK067R	295 x 280 x 36	JK068R	295 x 280 x 36	295 x 280 x 102 260 x 260 x 80
1/2	JK062R	295 x 275 x 135	JK067R	295 x 280 x 36	JK068R	295 x 280 x 36	295 x 280 x 150 260 x 260 x 125
1/1	JK262R	586 x 275 x 135	JK267R	586 x 280 x 36	JK268R	586 x 280 x 36	586 x 280 x 150 550 x 260 x 125

AESFULAP Aicon®

A JUMP AHEAD IN STERILE SUPPLY MANAGEMENT

Discover AESFULAP Aicon®



Scan the QR code or type in the link
below.

LINK:

www.bbraun.com/aesfulapaicon





reddot winner 2020



For more information about AESCULAP Aicon®, please refer to C93102

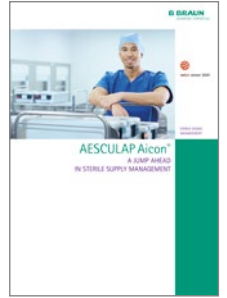

Sterile Containers



INSTRUMENT BASKETS

BASKET CONFIGURATOR

ILLUSTRATIVE OVERVIEW FOR JF BASKETS

WHICH BASKET GOES WITH WHICH CONTAINER BOTTOM?



JF SERIES

- Black PEEK plastic feet for stacking
- Fold-down handles on the side
- Mat surface
- 4 mm base perforation / 2 mm side perforation
- Can be combined with Aesculap InOS®
- Sloped edges

1/1 short

		Top basket								
		Basket in combination with:								
		Alone	JF211R	JF211R with lid*	JF212R	JF212R with lid*	JF213R	JF213R with lid*	JF214R	JF214R with lid*
Bottom basket	JF211R		JK441	JK441	JK441	JK442	JK442	JK444	JK444	JK444
	JF211R with lid*	JK440 JN440	JK441 JN441	JK441 JN441	JK442 JN442	JK442 JN442		JK444 JN444	JK444 JN444	JK444 JN446
	JF212R	JK440 JN441	JK441 JN442	JK442 JN442	JK442 JN444		JK444 JN444			
	JF212R with lid*	JK441 JN441	JK442 JN444	JK442 JN444		JK444 JN444	JK444 JN446			JK446 JN446
	JF213R	JK441 JN442			JK444 JN444				JK446 JN446	
	JF213R with lid*	JK442 JN444	JK444 JN444	JK444 JN444			JK444 JN446		JK446 JN446	
	JF214R	JK444 JN444			JK444 JN446	JK446 JN446	JK446 JN446	JK446 JN446		JK446
	JF214R with lid*		JK444 JN446		JK446 JN446				JK446	-

*JF217R lid



1 EXAMPLE

- Basket alone: JF212R (without lid)
- ➔ suitable container bottom: JK440 or JN441

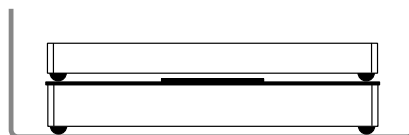

2 EXAMPLE

- Top basket: JF212R (without lid)
- Bottom basket: JF213R with lid
- ➔ suitable container bottom: JK444 or JN444

JK = Solid bottom
(fractionated vacuum process)



JN = Perforated bottom
(gravity process)



NOTE: ■ According to EN ISO 868-8, the load must not exceed a total of 10 kg in order to avoid excessive condensate formation.
■ Caution! The inner height and therefore the appropriate basket changes depending on whether JK or JN bottoms are used.



JF SERIES

- Black PEEK plastic feet for stacking
- Fold-down handles on the side
- Mat surface
- 4 mm base perforation / 2 mm side perforation
- Can be combined with Aesculap InOS®
- Sloped edges

1/1 long

Top basket

Basket in combination with:

		Alone	JF221R	JF221R with lid*	JF222R	JF222R with lid*	JF223R	JF223R with lid*	JF224R	JF224R with lid*
Bottom basket	JF221R		JK441	JK441 JN441	JK441 JN441	JK441 JN441	JK442 JN442	JK442 JN444	JK444 JN444	JK444 JN444
	JF221R with lid*		JK440 JN440	JK441 JN441	JK441 JN442	JK442 JN444	JK442 JN444	JK444 JN444	JK444 JN446	JK444 JN446
	JF222R		JK440 JN441	JK441 JN442	JK442 JN442	JK442 JN444	JK444 JN444	JK444 JN444	JK444 JN446	JK446 JN446
	JF222R with lid*		JK441 JN441	JK442 JN444	JK442 JN444	JK444 JN444	JK444 JN444	JK444 JN446	JK446 JN446	JK446 JN446
	JF223R		JK441 JN442	JK444 JN444	JK444 JN444	JK444 JN444	JK444 JN446	JK446 JN446	JK446 JN446	JK446 JN446
	JF223R with lid*		JK442 JN444	JK444 JN444	JK444 JN444	JK444 JN446	JK446 JN446	JK446 JN446	JK446 JN446	JK446 JN446
	JF224R		JK444 JN444	JK444 JN444	JK444 JN446	JK446 JN446	JK446 JN446	JK446 JN446	JK446 JN446	JK446 JN446
	JF224R with lid*		JK444 JN446	JK444 JN446	JK446 JN446	JK446 JN446	JK446 JN446	JK446 JN446	JK446 JN446	JK446 JN446

*JF227R lid



1 EXAMPLE

- Basket alone: JF222R (without lid)
- ➔ suitable container bottom: JK440 or JN441

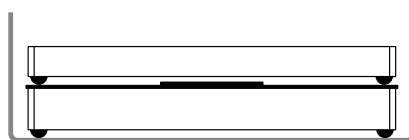

2 EXAMPLE

- Top basket: JF222R (without lid)
- Bottom basket: JF223R with lid
- ➔ suitable container bottom: JK444 or JN444

JK = Solid bottom
(fractionated vacuum process)



JN = Perforated bottom
(gravity process)



NOTE: ■ According to EN ISO 868-8, the load must not exceed a total of 10 kg in order to avoid excessive condensate formation.
 ■ Caution! The inner height and therefore the appropriate basket changes depending on whether JK or JN bottoms are used.

BASKET CONFIGURATOR

ILLUSTRATIVE OVERVIEW FOR JF BASKETS

WHICH BASKET GOES WITH WHICH CONTAINER BOTTOM?



JF SERIES

- Black PEEK plastic feet for stacking
- Fold-down handles on the side
- Mat surface
- 4 mm base perforation / 2 mm side perforation
- Can be combined with Aesculap InOS®
- Sloped edges

3/4

		Top basket								
		Basket in combination with:								
		Alone	JF251R	JF251R with lid*	JF252R	JF252R with lid*	JF253R	JF253R with lid*	JF254R	JF254R with lid*
Bottom basket	JF251R			JK741 JN741	JK741 JN742	JK742 JN742	JK742 JN744		JK744 JN744	JK744 JN744
	JF251R with lid*	JK740 JN740	JK741 JN741	JK741 JN742	JK742 JN744	JK742 JN744		JK744 JN744		JK744
	JF252R	JK740 JN741	JK741 JN742	JK742 JN742	JK742 JN744		JK744 JN744		JK744	-
	JF252R with lid*	JK741 JN741	JK742 JN744	JK742 JN744		JK744 JN744		JK744	-	-
	JF253R	JK741 JN742			JK744 JN744				-	-
	JF253R with lid*	JK742 JN744	JK744 JN744	JK744 JN744			JK744		-	-
	JF254R				JK744				-	-
	JF254R with lid*	JK744 JN744	JK744						-	-

*JF257R lid



1 EXAMPLE

- Basket alone: JF252R (without lid)
- ➔ suitable container bottom: JK740 or JN741

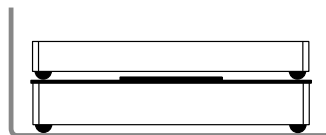

2 EXAMPLE

- Top basket: JF252R (without lid)
- Bottom basket: JF253R with lid
- ➔ suitable container bottom: JK744 or JN744

JK = Solid bottom
(fractionated vacuum process)



JN = Perforated bottom
(gravity process)



NOTE: ■ According to EN 868-8, the load must not exceed a total of 7.5 kg in order to avoid excessive condensate formation.
■ Caution! The inner height and therefore the appropriate basket changes depending on whether JK or JN bottoms are used.



JF SERIES

- Black PEEK plastic feet for stacking
- Fold-down handles on the side
- Mat surface
- 4 mm base perforation / 2 mm side perforation
- Can be combined with Aesculap InOS®
- Sloped edges

1/2

Top basket

Basket in combination with:

		Alone	JF111R	JF111R with lid*	JF112R	JF112R with lid*	JF113R	JF113R with lid*	JF114R	JF114R with lid*	
Bottom basket	JF111R	Container bottom	JK340	JK341	JK341	JK341	JK342	JK342	JK344	JK344	
	JF111R with lid*		JN340	JN341	JN341	JN342	JN344	JN344	JN344	JN344	
	JF112R		JK340	JK341	JK342	JK342	JK344 JN344	JK344 JN344	JK344 JN346	JK346 JN346	
	JF112R with lid*		JN341	JN342	JN342	JN344					
	JF113R		JK341	JK342	JK342	JK344 JN344	JK344 JN344	JK344 JN346	JK346 JN346	JK346 JN346	
	JF113R with lid*		JN342	JN344	JN344						JN344
	JF114R		JK344	JK344	JK344	JK344	JK346	JK346	JK346	JK346	JK346
	JF114R with lid*		JN344	JN344	JN344	JN346	JN346	JN346	JN346	JN346	JN346

*JF117R lid

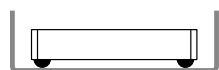

1 EXAMPLE

- Basket alone: JF112R (without lid)
- ➔ suitable container bottom: JK340 or JN341

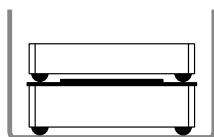

2 EXAMPLE

- Top basket: JF112R (without lid)
- Bottom basket: JF113R with lid
- ➔ suitable container bottom: JK344 or JN344

JK = Solid bottom
(fractionated vacuum process)



JN = Perforated bottom
(gravity process)









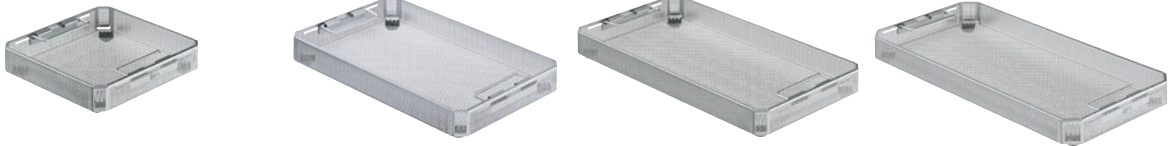

NOTE: ■ According to EN 868-8, the load must not exceed a total of 5 kg in order to avoid excessive condensate formation.
 ■ Caution! The inner height and therefore the appropriate basket changes depending on whether JK or JN bottoms are used.

BASKETS







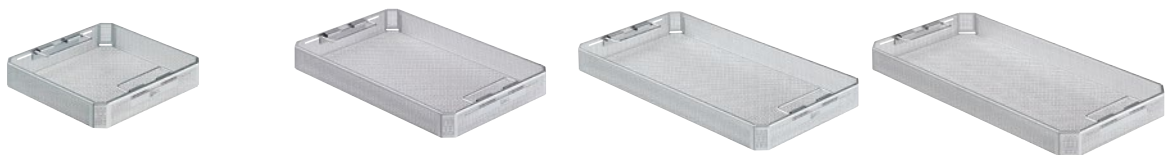

BASKET WITH FEET



		Outside dim. Inside dim.		Outside dim. Inside dim.		Outside dim. Inside dim.		Outside dim. Inside dim.
 36	JF111R	243 x 253 x 36 241 x 251 x 22	JF251R	406 x 253 x 36 404 x 251 x 22	JF211R	485 x 253 x 36 483 x 251 x 22	JF221R	540 x 253 x 36 538 x 251 x 22
 56	JF112R	243 x 253 x 56 241 x 251 x 42	JF252R	406 x 253 x 56 404 x 251 x 42	JF212R	485 x 253 x 56 483 x 251 x 42	JF222R	540 x 253 x 56 538 x 251 x 42
 76	JF113R	243 x 253 x 76 241 x 251 x 62	JF253R	406 x 253 x 76 404 x 251 x 62	JF213R	485 x 253 x 76 483 x 251 x 62	JF223R	540 x 253 x 76 538 x 251 x 62
 106	JF114R	243 x 253 x 106 241 x 251 x 92	JF254R	406 x 253 x 106 404 x 251 x 92	JF214R	485 x 253 x 106 483 x 251 x 92	JF224R	540 x 253 x 106 538 x 251 x 92

BASKET WITHOUT FEET



		Outside dim. Inside dim.		Outside dim. Inside dim.		Outside dim. Inside dim.		Outside dim. Inside dim.
 24	JG111R	243 x 253 x 24 241 x 251 x 22	JG251R	406 x 253 x 24 404 x 251 x 22	JG211R	485 x 253 x 24 483 x 251 x 22	JG221R	540 x 253 x 24 538 x 251 x 22
 44	JG112R	243 x 253 x 44 241 x 251 x 42	JG252R	406 x 253 x 44 404 x 251 x 42	JG212R	485 x 253 x 44 483 x 251 x 42	JG222R	540 x 253 x 44 538 x 251 x 42
 64	JG113R	243 x 253 x 64 241 x 251 x 62	JG253R	406 x 253 x 64 404 x 251 x 62	JG213R	485 x 253 x 64 483 x 251 x 62	JG223R	540 x 253 x 64 538 x 251 x 62
 94	JG114R	243 x 253 x 94 241 x 251 x 92	JG254R	406 x 253 x 94 404 x 251 x 92	JG214R	485 x 253 x 94 483 x 251 x 92	JG224R	540 x 253 x 94 538 x 251 x 92

BASKET INSERTS



		Outside dim. Inside dim.		Outside dim. Inside dim.		Outside dim. Inside dim.
34	JF110R	196 x 252 x 34 194 x 237 x 33	JF250R	305 x 252 x 34 303 x 237 x 33	JF210R	438 x 252 x 34 436 x 237 x 33

LID FOR BASKETS JF, JG



	Standard 1/2	Outside dim.	Standard 3/4	Outside dim.	Standard 1/1 short	Outside dim. Inside dim.	Standard 1/1 long	Outside dim. Inside dim.
	JF117R	247 x 257 x 18	JF257R	410 x 257 x 18	JF217R	489 x 257 x 18	JF227R	544 x 257 x 18
					JH217R	489 x 257 x 18 with 8 mm perforation		

Aesculap JF/JG baskets are made of stainless steel 1.4301 and of PEEK (feet, closure system basket lid)

BASKETS

SPECIAL TRAYS

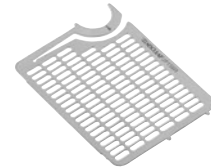

Tray base

Tray divider, fitting JF156R

4 mm perforation	Outside dim. Inside dim.
JF155R (lid included)	236 x 72 x 27 230 x 66 x 20

4 mm perforation	Outside dim. Inside dim.
JF156R	232 x 68 x 61 227 x 61 x 54

JF158R	



Lid, fitting JF156R and JF155R

4 mm perforation	Outside dim. Inside dim.
JF157R	236 x 72 x 11



For small objects, two trays fitting into an AESCULAP® mini sterile container, 2 each fitting into JK188 or JN188



For small objects or micro instruments



For micro instruments fitting into an AESCULAP® mini sterile container, fitting into JK188 or JN188

Mini	Outside dim. Inside dim.
JF149R (2 mm perforation)	135 x 120 x 47 128 x 113 x 38

4 mm perforation	Outside dim. Inside dim.
JF150R	235 x 137 x 42 229 x 131 x 35

Mini	Outside dim. Inside dim.
JF159R (4 mm perforation)	267 x 125 x 49 261 x 118 x 41



suitable sterile containers see page 43



suitable sterile containers see page 44

SPECIAL TRAYS



Tray with lid

	Outside dim. Inside dim.
JG487R	188 x 84 x 30 181 x 82 x 23



Tray with lid

	Outside dim. Inside dim.
JG488R	188 x 125 x 30 181 x 123 x 23



For small objects

	Outside dim. Inside dim.
JF145R 2 mm perforation	85 x 44 x 25 80 x 39 x 18
JF146R 4 mm perforation	85 x 44 x 25 80 x 39 x 18



For small objects

4 mm perforation	Outside dim. Inside dim.
JF140R	80 x 80 x 33 75 x 75 x 26



For small objects

4 mm perforation	Outside dim. Inside dim.
JF147R	354 x 44 x 35 349 x 39 x 28



For small objects

4 mm perforation	Outside dim. Inside dim.
JF148R	145 x 44 x 25 140 x 39 x 18

BASKETS

SPECIAL TRAYS



Tray without inserts, with lid handle fitting into dental sterile container JN294



Outside dim.
Inside dim.

JF264R 273 x 176 x 41
267 x 170 x 34



Tray with lid fitting into dental sterile container JN295



Outside dim.
Inside dim.

JG285R 273 x 176 x 60
267 x 170 x 53



Tray without lid fitting into dental sterile container JN296



Outside dim.
Inside dim.

JF282R 269 x 171 x 93
267 x 169 x 91



Lid for tray JF282R



Outside dim.

JF289R 273 x 176 x 16



Tray, contains three instrument racks (JG392), with lid handle, fitting into dental sterile container JN294



Outside dim.
Inside dim.

JG380R 273 x 84 x 41
267 x 78 x 34



Tray, contains three instrument racks (JG391), with lid handle, fitting into dental sterile container JN294



Outside dim.
Inside dim.

JG381R 273 x 176 x 30
267 x 170 x 23

SPECIAL TRAYS



Tray, with perforation for retractor, contains three instrument racks (JG391), with lid handle, fitting into dental sterile container JN294



Outside dim.
Inside dim.

JG383R 273 x 176 x 30
267 x 170 x 23



Tray, contains three instrument racks (JG393), with lid handle, fitting into dental sterile container JN294



Outside dim.
Inside dim.

JG384R 273 x 176 x 41
267 x 170 x 34



Tray, without inserts, with lid handle, fitting into dental sterile container JN294



Outside dim.
Inside dim.

JG386R 273 x 176 x 41
267 x 170 x 34



Tray, contains the instrument racks JG400 and JG401 for 6 instruments



Outside dim.
Inside dim.

JG387R 188 x 84 x 30
181 x 78 x 23



Tray, contains the instrument racks JG400 and JG401 for 9 instruments



Outside dim.
Inside dim.

JG388R 188 x 125 x 30
181 x 119 x 23



Tray, contains five instrument racks (2 x JG394, 2 x JG400, 1 x JG401), with lid handle, fitting into dental sterile container JN294



Outside dim.
Inside dim.

JG389R 273 x 176 x 30
267 x 170 x 23

SCOPE TRAYS

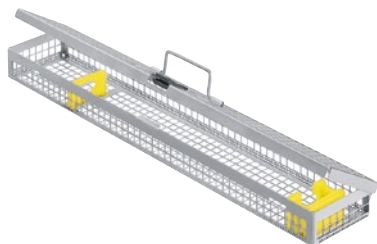

Tray for one scope of sheath length up to 340 mm.

	Outside dim.
JF431R	454 x 84 x 41 448 x 78 x 34

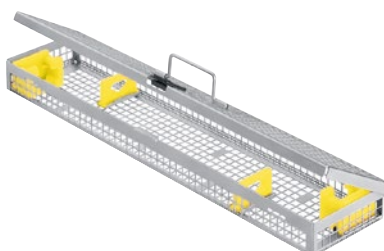

Tray for two scopes of sheath length up to 340 mm.

	Outside dim. Inside dim.
JF432R	454 x 104 x 41 448 x 98 x 34

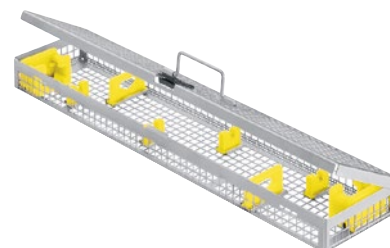

Tray for two scopes of sheath length up to 340 mm, with additional support.

	Outside dim. Inside dim.
JF433R	454 x 104 x 41 448 x 98 x 34

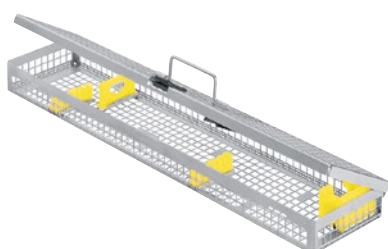

Tray for mini hysteroscope of < 4 mm diameter

	Outside dim. Inside dim.
JF434R	454 x 104 x 41 448 x 98 x 34



Tray for one arthroscope of 2.7 mm or 4 mm sheath diameter and sheath length 140 - 200 mm.

	Outside dim. Inside dim.
JF436R	273 x 84 x 41 267 x 78 x 34

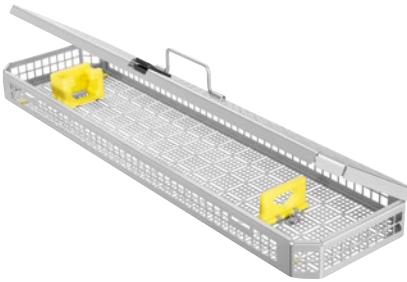

Tray like JF435R prepared for one scope and one light conducting cable (incl. 1x JG367 + 1x JG368), fitting scope container see page 45 ff.

	Outside dim. Inside dim.
JF428R	500 x 132 x 44 494 x 124 x 30

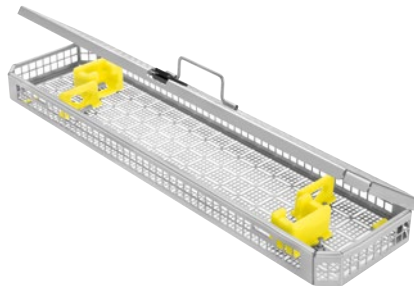

Tray like JF435R prepared for two scopes and one light conducting cable (incl. 2x JG367 + 2x JG368), fitting scope container see page 45 ff.

	Outside dim. Inside dim.
JF429R	500 x 132 x 44 494 x 124 x 30



Tray for up to two laparoscopic scopes and one light conducting cable (scope holders JG367 + JG368 please order separately), fitting scope container see page 45 ff.

	Outside dim. Inside dim.
JF435R	500 x 132 x 44 494 x 124 x 30

STORAGE RACK FOR MIC INSTRUMENTS AND TROCARS

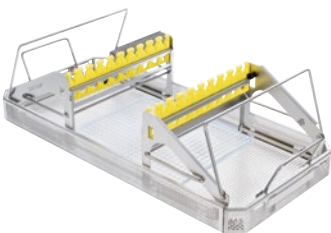

Storage rack set for MIS instruments and trocars, consisting of: Storage rack PL963R, instrument basket JF522R and silicone mat JF938, fitting JK444 and JK489.

Standard 1/1	Outside dim. Inside dim.
PL960R	540 x 253 x 166

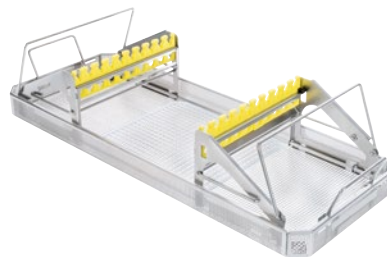

Storage rack set for MIS instruments, XXL, consisting of: Storage rack PL964R, instrument basket JF532R and silicone mat JF938, for instruments with shaft length up to 420 mm, fitting JN445 and JK490.

XXL	Outside dim. Inside dim.
PL961R	660 x 253 x 166



Storage rack, standard

	Outside dim.
PL963R	487 x 250 x 153



Storage rack, XXL

	Outside dim. Inside dim.
PL964R	587 x 250 x 153

STORAGE FRAME

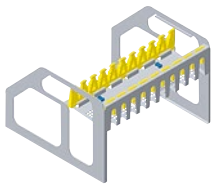

Storage frame
for bone punches

	Outside dim. Inside dim.
JF120R	240 x 225 x 151

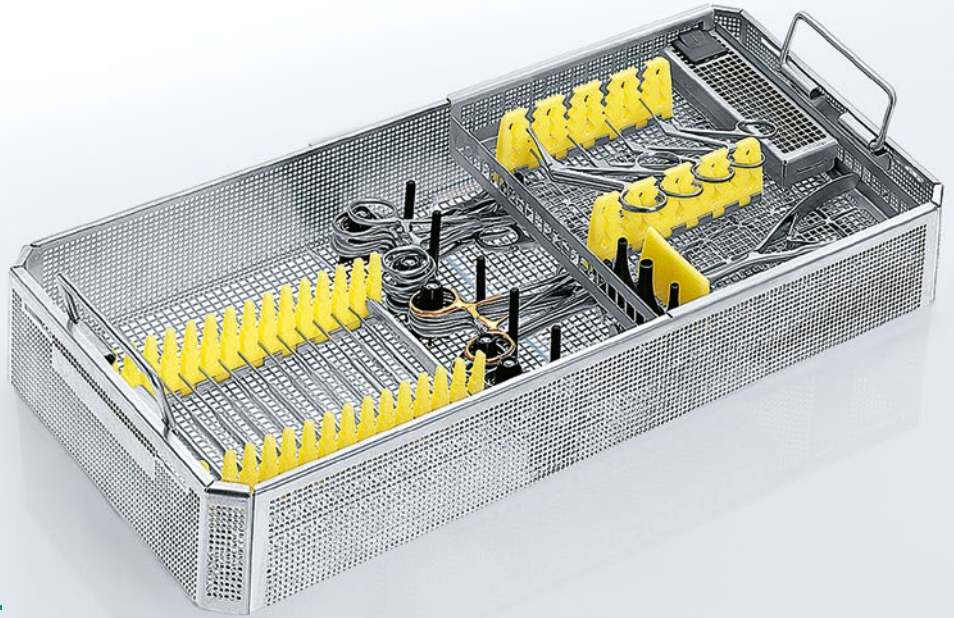

Aesculap InOS® - INSTRUMENT ORGANISATION SYSTEM

Aesculap InOS[®] – INSTRUMENT ORGANISATION SYSTEM

ORGANISATION AND PROTECTION OF SURGICAL INSTRUMENTS

Surgical instruments are valuable assets for every hospital, that is why they should be processed as efficiently and gently as possible.

Therefore, protecting the instruments during sterilisation, as well as in transport to sterile supply storage and to the operating room, is of crucial importance.

The Aesculap organisation system for instrument trays facilitates the storage especially of delicate instruments and small items.

*Transsphenoidal
hypophysectomy Set*

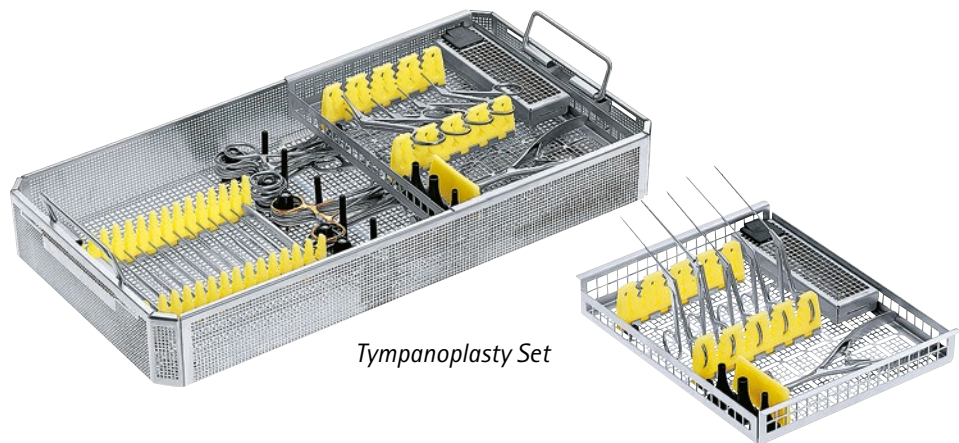
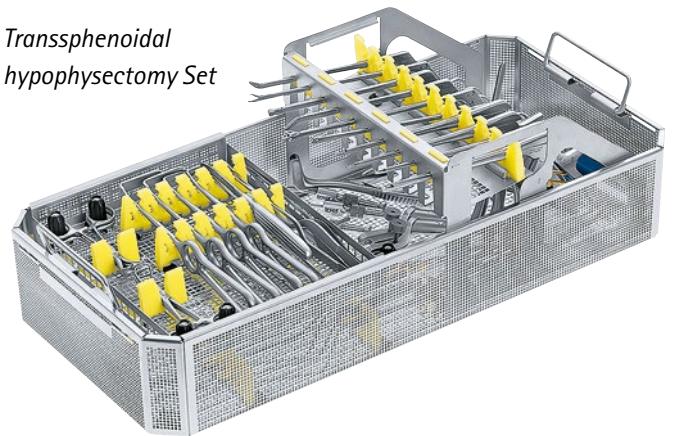

Tympanoplasty Set

Skull Set

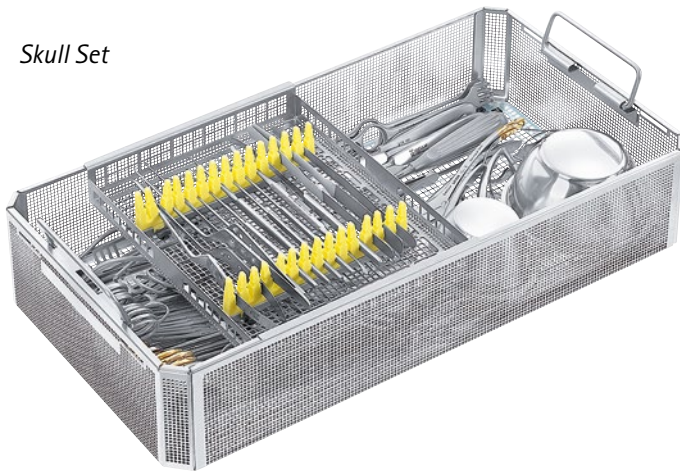



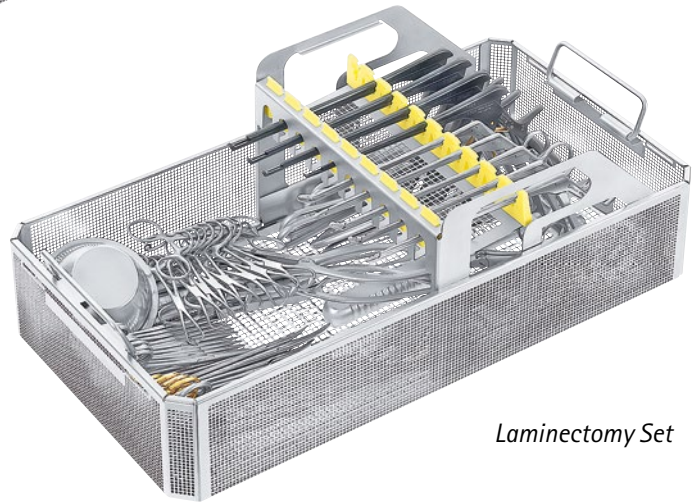



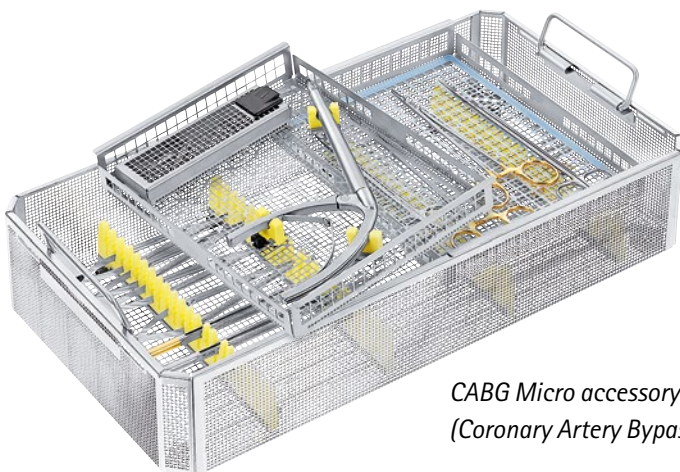



Laminectomy Set

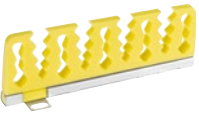







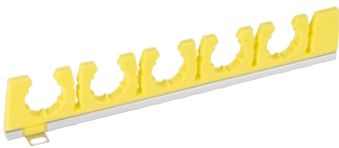









*CABG Micro accessory
(Coronary Artery Bypass Graft)*







Aesculap InOS® – INSTRUMENT ORGANISATION SYSTEM



INSTRUMENT RACKS* (MOUNTING A)		Interspaces	Outside dim.	Art. no.
 		7	120 x 40 mm	JG304
		9	160 x 40 mm	JG305
		15	240 x 40 mm	JG306
 		9	120 x 40 mm	JG308
		11	160 x 40 mm	JG309
		17	240 x 40 mm	JG310
 		6	120 x 40 mm	JG312
		8	160 x 40 mm	JG313
		12	240 x 40 mm	JG314
 		10	120 x 40 mm	JG316
		14	160 x 40 mm	JG317
		20	240 x 40 mm	JG318
 		20	120 x 40 mm	JG327
	for currettes	10	240 x 41 mm	JG311

INSTRUMENT RACKS FOR MICRO INSTRUMENTS* (MOUNTING A)			Interspaces	Outside dim.	Art. no.
			20	120 x 21 mm	JG320
			7	123 x 18 mm	JG321
			6	123 x 18 mm	JG322
			13	123 x 18 mm	JG323
			7	123 x 45 mm	JG324

INSTRUMENT RACKS FOR MICRO INSTRUMENTS* (MOUNTING A)			Interspaces	Outside dim.	Art. no.
		Positioning rack	19	160 x 30 mm	JG325
			29	240 x 30 mm	JG326
		Support for spring type micro instruments – handle end	4	120 x 40 mm	JG328
			2	60 x 40 mm	JG333
		Support for spring type micro instruments – jaw end	4	120 x 40 mm	JG329
			2	60 x 40 mm	JG334

Aesculap InOS® – INSTRUMENT ORGANISATION SYSTEM







HOLDERS WITH RAIL* (MOUNTING A)	Diameter	Art. no.
	5 mm	JG340
	7.5 mm	JG341
	8.5 mm	JG342
	10 mm	JG343
	12 mm	JG344





METAL CLAMP WITH SILICONE INLAY (MOUNTING A)	Diameter	Art. no.
	15 - 20 mm	JG352R
	20 - 30 mm	JG353R
	30 - 45 mm	JG354R





SEPARATING RACKS* (MOUNTING A)	Length	Art. no.
	120 x 40 mm	JG358
	160 x 40 mm	JG359
	243 x 40 mm	JG360



*** NOTE:**
 Unless noted otherwise, please order the screws JJ588R separately.

Aesculap InOS® – INSTRUMENT ORGANISATION SYSTEM

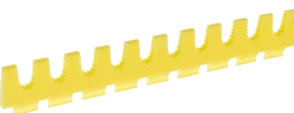
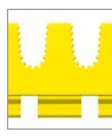

HOLDERS (MOUNTING A)		Diameter	Art. no.	Diameter	Art. no.
		15 mm	JG330	10 mm	JG335
		25 mm	JG331	7.5 mm	JG336
		30 mm	JG332	5 mm	JG337

SCOPE HOLDERS* (MOUNTING A)		Interspaces	Art. no.
		Eyepiece holder	JG367
		Sleeve holder	JG368
		Support for angled optics	JG369



RACK FOR BASKET INLAYS (MOUNTING C)		Interspaces	Outside dim.	Art. no.
			240 x 30 mm	JG370
		10	234 x 30 mm	JG371
		10	227 x 30 mm	JG372

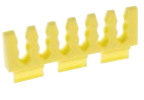

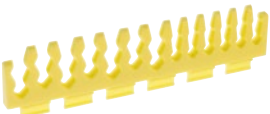

RACKS FOR SPECIAL TRAYS (MOUNTING A)		Interspaces	Outside dim.	Art. no.
		6	76 x 33 mm	JG396
		14	160 x 23 mm	JG397 (incl. holding screws)
		13	160 x 34 mm	JG398 (incl. holding screws)

Aesculap InOS® – INSTRUMENT ORGANISATION SYSTEM

INSTRUMENT RACKS FOR SPECIAL TRAYS WITH 30 MM HEIGHT (MOUNTING C)	Interspaces	Outside dim.	Art. no.
	13	159 x 14 mm	JG400
	6	74 x 22 mm	JG394
	10	115 x 22 mm	JG395
	14	158 x 22 mm	JG391



*** NOTE:**
Unless noted otherwise, please order the screws JJ588R separately.



INSTRUMENT RACKS FOR SPECIAL TRAYS WITH 41 MM HEIGHT (MOUNTING C)	Interspaces	Outside dim.	Art. no.
	6	76 x 33 mm	JG392
	13	158 x 33 mm	JG393
		158 x 30 mm	JG390

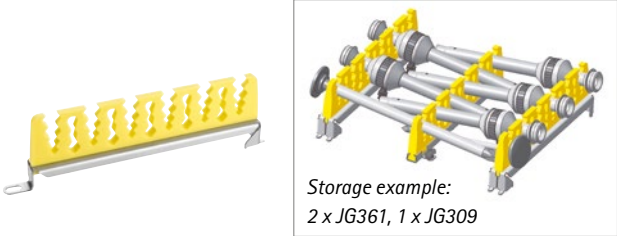

TOP HOLDER		Outside dim.	Art. no.
		113 x 21 mm	JG378
	<p>Press pad, for suppressing the instrument, to assemble to the lower side of the lid.</p>	113 x 31 mm	JG379
		150 x 15 mm	JG399
		158 x 14 mm	JG401

Aesculap InOS® – INSTRUMENT ORGANISATION SYSTEM

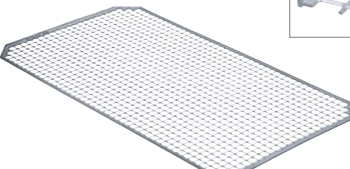

TROCAR RACK (MOUNTING A)	Interspaces	Outside dim.	Art. no.
 <p>Storage example: 2 x JG361, 1 x JG309</p>	11	167 x 53 mm	JG361

FIXATION ELEMENTS FOR MOUNTING A		Art. no.
	Screw set, for an easy assembly solely use a socket wrench AF7, such as JJ589R Order unit (PAK): Pack of 10	JJ588R
	Socket wrench AF7 for screw set JJ588R	JJ589R

FIXATION PINS FOR RING HANDLE INSTRUMENTS	Diameter	Art. no.
	25 mm, height 29 mm	JF346
	6 mm, height 47 mm	JF343
Note: does not fit into JJ baskets (AESCULAP Aicon®)		

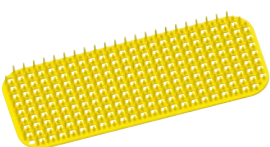
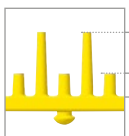
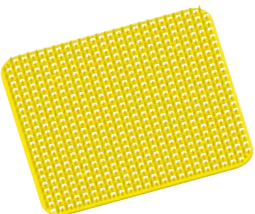
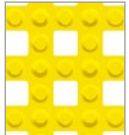
SILICONE MATS (MESH)		Outside dim.	Art. no.
 	fitting to 1/2 basket	240 x 250 mm	JF938
	fitting to 3/4 basket	402 x 250 mm	JF940
	fitting to 1/1, short basket	480 x 250 mm	JF939
	fitting to 1/1, long basket	536 x 250 mm	JF941

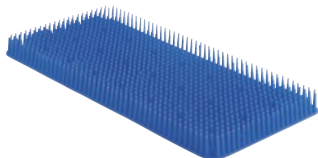
SILICONE MATS WITH PERFORATION (NUBS)		Outside dim.	Art. no.
 	fitting to JF159R	248 x 102 mm	JF944
 	fitting to 1/2 basket	248 x 237 mm	JF945
	fitting to 3/4 basket	394 x 242 mm	JF947
	fitting to 1/1, short basket	472 x 242 mm	JF948
	fitting to 1/1, long basket	517 x 242 mm	JF949

POSITIONING MAT		Outside dim.	Art. no.
		470 x 230 x 30 mm	JF932
 	Mini	276 x 125 x 17 mm	JF934

Aesculap InOS® – INSTRUMENT ORGANISATION SYSTEM

STORAGE SOLUTION FOR HEGAR UTERINE DILATORS

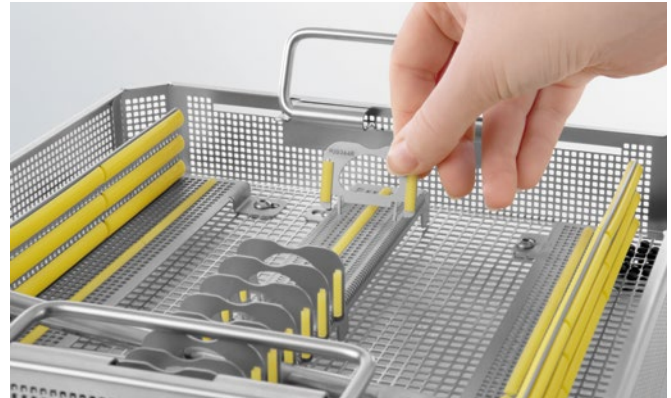
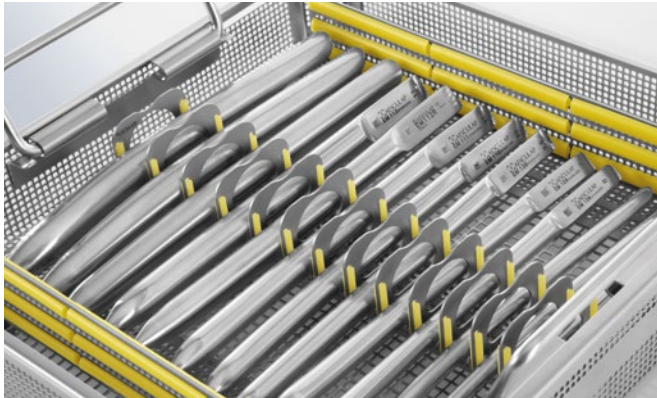



Example:

- 1 x JG362R center bar
- 2 x JG363R angle bar
- 10 to 15 dividers JG364R
- 1 x JF112R 1/2 basket
- 1 x JF117R 1/2 basket lid (not depicted)

Also fitting

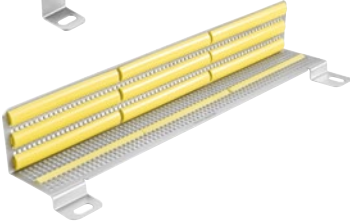
- 1 x JJ262R AESCULAP Aicon® 1/2 basket without lid or
- 1 x JJ263R AESCULAP Aicon® 1/2 basket with lid
- JJ267R (not depicted)

STORAGE SOLUTION FOR UTERINE DILATORS	Outside dim.	Art. no.
 <p>Center bar with fixation screws</p>	213 x 67 x 16 mm	JG362R
 <p>Angle bar with fixation screws</p>	213 x 50 x 42 mm	JG363R
 <p>Divider for center bar JG362R</p>	40 x 5 x 30 mm	JG364R

MOUNTING INSTRUCTIONS

MOUNTING A for instrument racks to be fixed with screws

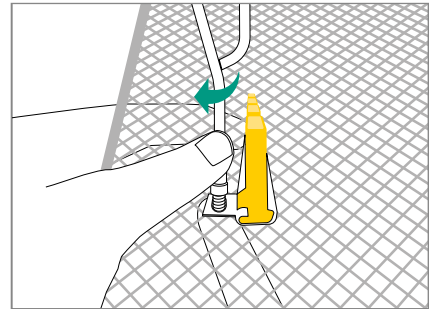
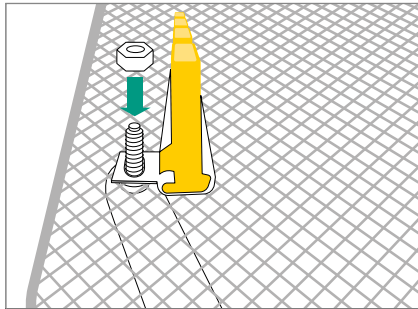
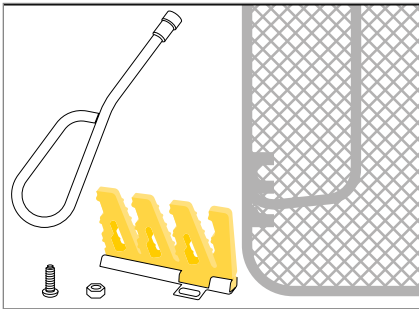

MATERIALS REQUIRED:

- Screw set JJ588R
- Socket wrench JJ589R
- Instrument holder such as JG341
- AESCULAP baskets (e. g. AESCULAP Aicon® JJ series or JF/JG series)

Place the instrument holder in the required position in the AESCULAP basket, making sure that the holder's fixation lug fit onto the basket's lattice-work correctly. Push the screw through from below and fix it with the nut from above.

Hold the screw with your finger, put on the socket wrench with the other hand and tighten the nut.

MOUNTING C for silicone racks in basket inserts

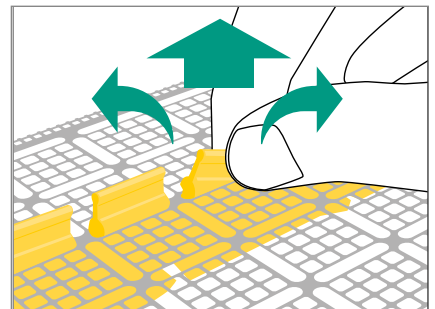
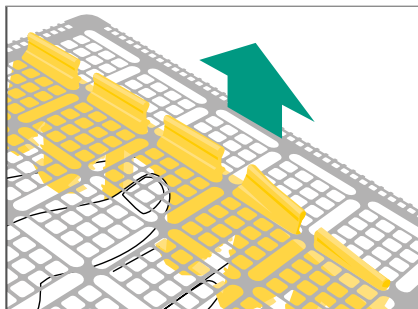
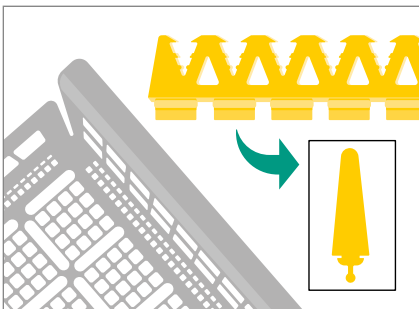

MATERIALS REQUIRED:

- Basket inserts JF110R, JF250R or JF210R
- Instrument rack, such as JG372

Push the fixation lugs through the longitudinal slots in the basket.

To pull the lugs through the slot completely, move left and right while applying tension.

Aesculap InOS[®] – INSTRUMENT ORGANISATION SYSTEM

HOLDING CLAMPS

Not for AESCULAP Aicon[®] baskets
(JJ-series)



	Outside dim. Effective dim.
JG691R	24 x 28 x 25 Ø 7-12 mm

Holding clamp



	Outside dim. Effective dim.
JG692R	24 x 28 x 29 Ø 12-16 mm

Holding clamp



	Outside dim. Effective dim.
JG693R	24 x 28 x 31 Ø 16-26 mm

Holding clamp



	Outside dim. Effective dim.
JG694R	24 x 28 x 40 Ø 16-36 mm

Holding clamp



	Outside dim. Effective dim.
JG695R	24 x 28 x 44 Ø 36-46 mm

Holding clamp

FIXATION ELEMENTS

Not for AESCULAP Aicon® baskets
(JJ-series)



	External dim.	
JG696R	Ø 6.0 x 20	Holding pin – e.g. for motor accessories
JG702R	Ø 4.9 x 20	Holding pin – e.g. for bone flaps
JG703R	Ø 4.5 x 22	Holding pin – e.g. for coriotome heads
JG706R	Ø 6.0 x 28	Holding pin – e.g. for motor accessories
JG708R	Ø 6.0 x 45	Holding pin – e.g. for motor accessories

Aesculap InOS® – INSTRUMENT ORGANISATION SYSTEM

STOP FRAMES



	Outside dim.
JF921R	110 x 15 x 28

Stop frame,
with fastening screws.



	Outside dim.
JF922R	174 x 15 x 28

Stop frame,
with fastening screws.

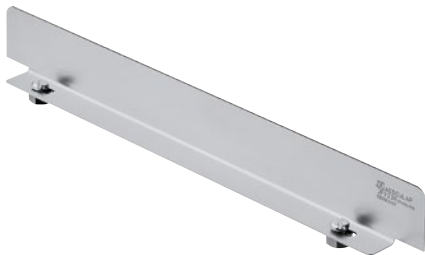

	Outside dim.
JF923R	244 x 15 x 28

Stop frame,
with fastening screws.



	Outside dim.
JF378R	164 x 27 x 12

Stop frame,
with fastening screws.

ACCESSORIES



ACCESSORIES

IDENTIFICATION LABELS



- JG785B red
- JG786B blue
- JG787B green
- JG788B gold
- JG790B black
- JG792B olive-brown
- JG793B violet
- JG794B orange

Identification labels with lettering one line or two lines (character height 5 mm), up to 13 characters per line. Dimensions: 56 x 18 mm for all Standard sterile containers except JK299, JK309 and JK339.

NOTE: Process aluminum identification labels with pH-neutral cleaning agent.



- JG785U red
- JG786U blue
- JG787U green
- JG788U gold
- JG790U black
- JG792U olive-brown
- JG793U violet
- JG794U orange

Identification labels without lettering

Specifications as above

NOTE: Process aluminum identification labels with pH-neutral cleaning agent.



- JG645B red
- JG646B blue
- JG647B green
- JG648B gold
- JG650B black
- JG652B olive-brown
- JG653B violet
- JG654B orange

Identification labels with lettering one line or two lines (character height 5 mm), up to 13 characters per line. Dimensions: 50 x 18 mm for mini-, dental-, scope sterile container, disposal container and JK299, JK309, JK339.

NOTE: Process aluminum identification labels with pH-neutral cleaning agent.



- JG645U red
- JG646U blue
- JG647U green
- JG648U gold
- JG650U black
- JG652U olive-brown
- JG653U violet
- JG654U orange

Identification labels without lettering

Specifications as above

NOTE: Process aluminum identification labels with pH-neutral cleaning agent.



IDENTIFICATION LABELS



	Outside dim.
JG736	56 x 18

Bar code labels, plastic, general, suitable for the label holder on AESCULAP® sterile containers. type 128, 10 characters max. code length, 10 characters max. lettering length.

SPECIAL NOTE:

Please specify the required designation in your order. Bar code and designation represent the same content. Also fitting into holder JG730.

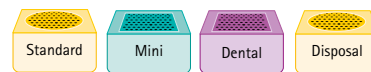

	Outside dim.
IC-V006	56 x 18

Bar code labels, plastic, for instacount®, fitting into the label holder on AESCULAP® sterile containers. type 128, 10 characters max. code length, 20 characters max. lettering length.

SPECIAL NOTE:

Please specify the required designation and the serial number of the instacount set.



	Outside dim.
JG730U	50 x 35 x 13

Holder for identification labels, for mounting on the trays, blank.



	Outside dim.
JG730B	50 x 35 x 13

Holder for identification labels, for mounting on the trays. Lettered (one line, max. 14 characters/line, character height max. 4 mm).

ACCESSORIES

IDENTIFICATION LABELS



	Outside dim.
JG625R	50 x 20 x 4

Holder for identification labels, to be mounted on baskets.



	Outside dim.
JG636R	33 x 20

Identification label for baskets, with lettering (one-line or two-line), up to 8 characters per line, character height 5 mm.



	Outside dim.
JG616U	58 x 23
JG616B	58 x 23

Identification label for baskets, for barcode tags.

Identification label for baskets, with lettering (one-line or two-line), up to 14 characters per line, character height 5 mm.



	Outside dim.
JG617U	89 x 30
JG617B	89 x 30

Identification label for baskets, for barcode tags.

Identification label for baskets, with lettering (one-line or two-line), up to 20 characters per line, character height 5 mm.



	Outside dim.
JJ586U	96 x 34
JJ586B	96 x 34

Identification label for baskets, for barcode tags.

Identification label for baskets, with lettering (one-line, two-line or three-line), up to 13 characters per line, character height 5 mm.



	Outside dim.
JJ587U	105 x 54
JJ587B	105 x 54

Identification label for baskets, for barcode tags.

Identification label for baskets, with lettering (one-line, two-line or three-line), up to 13 characters per line, character height 5 mm.

DISPOSAL STAMPS



	Outside dim.
JG673B	40 x 35 x 9
JG673U	40 x 35 x 9

Disposal stamp with lettering
(one-line or two-line), up to 14 characters per line.

Disposal stamp, blank
Order unit: ST = pieces



	Outside dim.
JG675B	40 x 35 x 9
JG675U	40 x 35 x 9

Disposal stamp with lettering
one line, up to 3 digits (numerical only).

Disposal stamp, blank
Order unit: PR = pair



	Outside dim.
JG690R	393 x 85 x 155

Storage stand
for disposal stamps.

FIXATION CLAMP



	Outside dim.
JF484R	65 x 20 x 20

Fixation clamp
for clamping together baskets and containers
that are arranged next to each other on the prep
table.



	Outside dim.
JF509R	50 x 20 x 12

Fixation clamp
for wrapping drapes.

ACCESSORIES

FILTER ACCESSORIES



JK100

Universal filter retention plate for reusable filters and paper filters, fitting for all lid and body components of standard sterile containers.



JG731R

Bar code identification ring for filter retention plate. For recording the cycle count of reusable filter JK090. Lettering acc. to specification, up to 6 digits with bar code BC128.



JK098

Outside dim.

245 x 100 x 6

Universal filter retention plate for reusable and paper filters, fitting for all lid and base components of mini, dental and scope sterile containers.



JK096

Outside dim.

197 x 197 x 40

Filter dispenser for round filters.



JP050

Filter insert for PRIMELine® and PRIMELine® PRO lids validated for 5,000 sterilization cycles.



JP055

Mounting handle for filter insert, PRIMELine® and PRIMELine® PRO lids.



CONSUMABLES

CONSUMABLES

REUSABLE FILTERS



 Standard	Outside dim.
JK090	Ø 190

AESCULAP® reusable filter, round for use in up to 1,000 cleaning and sterilization cycles.

Order unit (PAK): Pack of 10





 Standard	Outside dim.
JK089	225 x 225

AESCULAP® reusable filter, square for legacy standard sterile containers, service life 1,000 cleaning and sterilization cycles.

Order unit (PAK): Pack of 10



 Mini  Dental	Outside dim.
JK091	95 x 215

AESCULAP® reusable filter for mini, dental and scope sterile containers with filter retention plate JK098, service life 1,000 cleaning and sterilization cycles.

Order unit (PAK): Pack of 2



 Dental	Outside dim.
JK092	171 x 231

AESCULAP® reusable filter for dental sterile containers without filter retention plate JK098, service life 1,000 cleaning and sterilization cycles.

Order unit (PAK): Pack of 2

PAPER FILTERS





 Standard	Outside dim.
JK095	Ø 190

AESCULAP® paper filter with process indicator for steam sterilization*.

Order unit (PAK): Pack of 100



 Mini  Dental	Outside dim.
JF166	118 x 235

AESCULAP® paper filter for mini, dental and scope sterile containers with process indicator for steam sterilization*, for use with filter retention plate JK098.

Order unit (PAK): Pack of 100



 Dental	Outside dim.
JF066	171 x 232

AESCULAP® paper filter for dental sterile containers with process indicator for steam sterilization*, for use without filter retention plate JK098.

Order unit (PAK): Pack of 100



 Standard	Outside dim.
JF481	230 x 230

AESCULAP® paper filter, square for legacy standard sterile containers without process indicator.

Order unit (PAK): Pack of 100

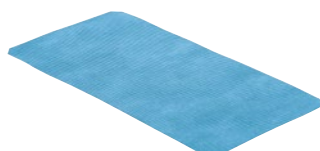

 Scope	Outside dim.
JF167	235 x 118

Disposable filter for the hydrogen peroxide sterilisation in Sterrad® 100S, Sterrad® 200, Sterrad® NX, Sterrad® 100NX, Steris V-Pro® 1 and Steris V-Pro® 1 Plus.

Order unit (PAK): Pack of 100

* acc. to EN ISO 11140-1 type 1

CONSUMABLES

INDICATOR LABELS

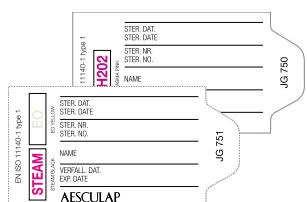
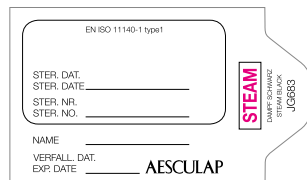
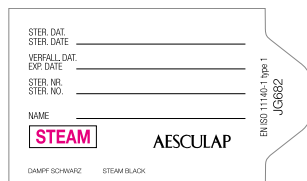
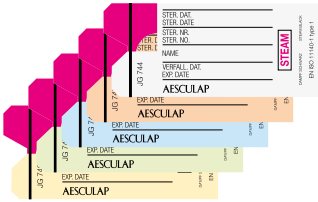

Standard	Color	Outside dim.
JG744	white	80 x 35
JG745	red	80 x 35
JG746	blue	80 x 35
JG747	green	80 x 35
JG748	yellow	80 x 35

Standard	Outside dim.
JG743	80 x 35

Mini Dental	Outside dim.
JG687	60 x 18

	Outside dim.
JG682	67 x 40

	Outside dim.
JG683	67 x 40

Scope	Outside dim.
JG750	67 x 35
JG751	67 x 35

Indicator seal with adhesive back and process indicator for steam sterilization*; safeguarding the sterile container against unauthorized opening. For standard sterile containers.

Order unit (PAK): Pack of 1,000

Seal without adhesive back and process indicator for steam sterilization; safeguarding the sterile container against unauthorized opening. For standard sterile containers.

Order unit (PAK): Pack of 1,000

Indicator label with adhesive back and process indicator for steam sterilization* for mini and dental sterile containers, container bottom JK339.

Order unit (PAK): Pack of 100

Indicator label with process indicator for steam sterilization* for legacy standard sterile containers.

Order unit (PAK): Pack of 1,000

Indicator label with adhesive back and process indicator for steam sterilization, for legacy standard sterile containers.

Order unit (PAK): Pack of 1,000

Identification label with adhesive back and process indicator for sterilisation with vaporized hydrogen peroxide*.

Order unit (PAK): Pack of 100

Identification label with adhesive back and process indicator for steam sterilisation* and sterilisation with ethylene oxide*.

Order unit (PAK): Pack of 100

SEALS

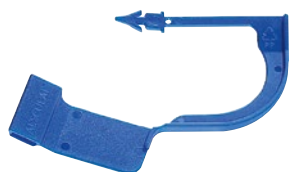

JG738
JG739

Seal - safeguarding the sterile container against unauthorized opening.
 Order unit (PAK): Pack of 100
 Order unit (PAK): Pack of 1,000



JG739W

Seal - for AEscULAP® sterile container till year of construction 1987 and AEscULAP® mini and dental sterile containers till year of construction 1999 (locking flap at the container bottom).
 Order unit (PAK): Pack of 1,000



JG740

Repair stamp - for marking instruments for repair or sterile containers holding materials due for repair.
 Order unit (PAK): Pack of 1,000



JG752
JG753

Seal - safeguarding the sterile container against unauthorized opening, with process indicator for steam sterilization*.
 Order unit (PAK): Pack of 100
 Order unit (PAK): Pack of 1,000

* acc. to EN ISO 11140-1 type 1

CONSUMABLES

MAINTENANCE PRODUCTS



JG598

STERILIT® I

AESCULAP® instrument oil for lubrication of links, locks, etc. prior to sterilization.

Contents: 50 ml



JG600

STERILIT® I – including 6 spraying nozzles
AESCULAP® oil spray for lubrication of links, locks, etc. prior to sterilization.

Contents: 300 ml

Order unit: Pack of 6



JG601

Eloxal cleaner

for cleaning and care of sterile container aluminium surfaces.

Contents: 300 ml

LABELS, BAR CODE LABELS



IC-V004

Roll of labels, double self-adhesive, outward rolled, without indicator, for cutting tool.

Length 70 m (approx. 2,000 labels 35 mm high), width 75 mm, roll core diameter 3", order unit (ST).

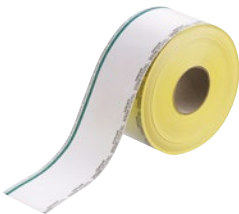

IC-V001

Roll of labels, double self-adhesive, outward roll, with process indicator for steam sterilization acc. to EN ISO 11140-1 type 1, for cutting instruments.

Length 70 m (approx. 2,000 labels 35 mm high), width 77 mm, order unit (ST).



IC-V002

Individual labels, double self-adhesive, outward rolled, without indicator, for dispenser sensor.

Label height 35 mm, label width 75 mm, roll core diameter 3", order unit (ST).



IC-V005

Individual labels, double self-adhesive, outward rolled, for dispenser sensor.

Label height 35 mm, label width 75 mm, roll core diameter 3", order unit (ST).



IC-V003

Thermotransfer ribbon, wax, inside print.

Length 360 m, width 76.5 mm, core diameter 1", order unit (ST).



IC-V008

Thermotransfer ribbon, wax, outside print.

Length 300 m, width 80 mm, core diameter 1", order unit (ST).

CONSUMABLES

LABELS, PRINTER ACCESSORIES



IC-V012

Individual labels, double side self adhesive, outside wound, with process indicator, with EN ISO 11140-1 type 1, for cutting tool.

1.500 labels perforated, label height 35 mm, width 78 mm; core diameter 3".



IC-V013

Endless labels, single side self adhesive, outside wound, with process indicator for steam sterilization in compliance with EN ISO 11140-1 type 1, for cutting tool.

Length 70 m (approx. 2000 labels at a height of 35 mm); width 77 mm; core diameter 3".



IC-V017

Tag label, special foil, triple-layer, white.

Outer format 75 x 265 mm
Order unit (PAK): Pack of 500

TROLLEYS

TROLLEYS



Outside dim.	
JF902	1030 x 600 x 1250

Shelf cart - two wheels with immobilization brake.
Three full-length storage surfaces, not adjustable.
Admissible total weight: 200 KG, uniformly distributed.

For sterile containers up to 280 mm high.



Outside dim.	
JF903	1100 x 680 x 1300

Cupboard cart - with wing doors for protection from dust. Two wheels with immobilization brake.
Three full-length storage surfaces, not adjustable.
Admissible total weight: 200 KG, uniformly distributed.

For sterile containers up to 280 mm high.



Outside dim.	
JF793	600 x 340 x 1180

Shelf cart - Mobile.
Storage shelves are not adjustable. Admissible total weight: 100 KG, uniformly distributed.

1 segment for sterile containers up to 280 mm high
3 segments for sterile containers up to 155 mm high

PREP TABLE



Outside dim.

JF890R 685 x 685 x **800**

Sterile prep table for sterile containers

- Table top 685 x 685 mm, working height 800 mm
- Storage rails for lids
- Impact protection wall deflectors
- Mobile, 2 wheels with immobilization brake.

Admissible total weight: 80 KG, uniformly distributed.

DISPOSAL CART



Outside dim.

JF820 760 x 397 x **900**

Disposal cart for containers

- 2 storage surfaces
- Working height 900 mm
- Mobile, 2 wheels with immobilization brake

Admissible total weight: 80 KG, uniformly distributed.

INDEX

INDEX

ARTICLE NO.	PAGE	ARTICLE NO.	PAGE	ARTICLE NO.	PAGE
IC-V001	97	JF227R	59	JF944	79
IC-V002	97	JF232R	48	JF945	79
IC-V003	97	JF236R	48	JF947	79
IC-V004	97	JF250R	59	JF948	79
IC-V005	97	JF251R	58	JF949	79
IC-V006	87	JF252R	58	JG111R	58
IC-V008	97	JF253R	58	JG112R	58
IC-V012	98	JF254R	58	JG113R	58
IC-V013	98	JF257R	59	JG114R	58
IC-V017	98	JF264R	62	JG211R	58
JF066	93	JF282R	62	JG212R	58
JF110R	59	JF289R	62	JG213R	58
JF117R	59	JF343	78	JG214R	58
JF120R	66	JF346	78	JG221R	58
JF140R	61	JF378R	84	JG222R	58
JF145R	61	JF428R	65	JG223R	58
JF146R	61	JF429R	65	JG224R	58
JF147R	61	JF431R	64	JG251R	58
JF148R	61	JF432R	64	JG252R	58
JF149R	60	JF433R	64	JG253R	58
JF150R	60	JF434R	64	JG254R	58
JF155R	60	JF435R	46, 65	JG285R	62
JF156R	60	JF436R	64	JG304	70
JF157R	60	JF481	93	JG305	70
JF158R	60	JF484R	89	JG306	70
JF159R	60	JF509R	89	JG308	70
JF166	46	JF793	100	JG309	70
JF166	93	JF820	101	JG310	70
JF167	47	JF890R	101	JG311	70
JF167	93	JF902	100	JG312	70
JF210R	59	JF903	100	JG313	70
JF211R	58	JF921R	84	JG314	70
JF212R	58	JF922R	84	JG316	70
JF213R	58	JF923R	84	JG317	70
JF214R	58	JF932	79	JG318	70
JF217R	59	JF933	48	JG320	71
JF221R	58	JF934	79	JG321	71
JF222R	58	JF938	79	JG322	71
JF223R	58	JF939	79	JG323	71
JF224R	58	JF940	79	JG324	71
		JF941	79	JG325	71

ARTICLE NO.	PAGE	ARTICLE NO.	PAGE	ARTICLE NO.	PAGE
JG326	71	JG391	76	JG675U	89
JG327	70	JG392	77	JG682	94
JG328	71	JG393	77	JG683	94
JG329	71	JG394	76	JG687	94
JG333	71	JG395	76	JG690R	89
JG334	71	JG396	75	JG692R	82
JG335	74	JG397	75	JG693R	82
JG336	74	JG398	75	JG694R	82
JG337	74	JG399	77	JG695R	82
JG340	72	JG400	76	JG696R	83
JG341	72	JG401	77	JG702R	83
JG342	72	JG487R	61	JG703R	83
JG343	72	JG488R	61	JG706R	83
JG344	72	JG598	96	JG708R	83
JG352R	73	JG600	96	JG730B	87
JG353R	73	JG601	96	JG730U	87
JG354R	73	JG616B	88	JG731R	90
JG358	73	JG616U	88	JG736	87
JG359	73	JG617B	88	JG738	95
JG360	73	JG617U	88	JG739	95
JG361	78	JG625R	88	JG739W	95
JG362R	80	JG636R	88	JG740	95
JG363R	80	JG645B	86	JG743	94
JG364R	80	JG645U	86	JG744	94
JG367	74	JG646B	86	JG745	94
JG368	74	JG646U	86	JG746	94
JG369	74	JG647B	86	JG747	94
JG370	75	JG647U	86	JG748	94
JG371	75	JG648B	86	JG750	47, 94
JG372	75	JG648U	86	JG751	46, 94
JG378	77	JG650B	86	JG752	95
JG379	77	JG650U	86	JG753	95
JG380R	62	JG652B	86	JG785B	86
JG381R	62	JG652U	86	JG785U	86
JG383R	63	JG653B	86	JG786B	86
JG384R	63	JG653U	86	JG786U	86
JG386R	63	JG654B	86	JG787B	86
JG387R	63	JG654U	86	JG787U	86
JG388R	63	JG673B	89	JG788B	86
JG389R	63	JG673U	89	JG788U	86
JG390	77	JG675B	89	JG790B	86

INDEX

ARTICLE NO.	PAGE	ARTICLE NO.	PAGE	ARTICLE NO.	PAGE
JG790U	86	JK339	28 ff	JK476A	30
JG792B	86	JK340	28 ff	JK477A	30
JG792U	86	JK341	28 ff	JK478A	30
JG793B	86	JK342	28 ff	JK479A	30
JG793U	86	JK344	28 ff	JK485	30
JG794B	86	JK346	28 ff	JK486	30
JG794U	86	JK355A	40	JK487	30
JH217R	59	JK356A	40	JK488	30
JJ586B	88	JK357A	40	JK489	30
JJ586U	88	JK358A	40	JK490	48
JJ587B	88	JK359A	40	JK740	26 ff
JJ587U	88	JK368	40	JK741	26 ff
JJ588R	78	JK369	40	JK742	26 ff
JJ589R	78	JK375A	34	JK744	26 ff
JK020	46	JK376A	34	JK755A	38
JK060R	49	JK377A	34	JK756A	38
JK062R	49	JK378A	34	JK757A	38
JK067R	49	JK379A	34	JK758A	38
JK068R	49	JK385	34	JK759A	38
JK089	92	JK386	34	JK769	38
JK090	92	JK387	34	JK775A	32
JK091	46, 92	JK388	34	JK776A	32
JK092	92	JK389	34	JK777A	32
JK095	93	JK395	34	JK778A	32
JK096	90	JK396	34	JK779A	32
JK098	47, 90	JK397	34	JK785	32
JK100	90	JK398	34	JK786	32
JK170	43	JK399	34	JK787	32
JK171	43	JK440	24 ff	JK788	32
JK172	43	JK441	24 ff	JK789	32
JK173	43	JK442	24 ff	JM020	47
JK174	43	JK443	48	JM021	47
JK187	43	JK444	24 ff	JM188	43
JK188	43	JK446	24 ff	JN021	46
JK262R	49	JK455A	36	JN086	44
JK267R	49	JK456A	36	JN088	44
JK268R	49	JK457A	36	JN089	44
JK286	44	JK458A	36	JN090	44
JK288	44	JK459A	36	JN091	44
JK289	44	JK469	36	JN092	44
JK290	44	JK475A	30	JN094	44

ARTICLE NO.	PAGE
JN095	44
JN096	44
JN187	43
JN188	43
JN292	44
JN294	44
JN295	44
JN296	44
JN340	34 ff
JN341	34 ff
JN342	34 ff
JN344	34 ff
JN346	34 ff
JN440	30 ff
JN441	30 ff
JN442	30 ff
JN443	48
JN444	30 ff
JN445	48
JN446	30 ff
JN740	32 ff
JN741	32 ff
JN742	32 ff
JN744	32 ff
JP050	90
JP055	90
JP101	24
JP102	24
JP103	24
JP104	24
JP105	24
JP111	26
JP112	26
JP113	26
JP114	26
JP115	26
JP121	28
JP122	28
JP123	28
JP124	28
JP125	28

ARTICLE NO.	PAGE
JP131	28
JP132	28
JP133	28
JP134	28
JP135	28
PL960R	65
PL961R	48
PL961R	65
PL963R	66
PL964R	66

AESCULAP® – a B. Braun brand

Aesculap AG | Am Aesculap-Platz | 78532 Tuttlingen | Germany
Phone +49 7461 95-0 | Fax +49 7461 95-2600 | www.aesculap.com

The main product trademark "Aesculap" and the product trademarks "PRIMELine", "instacount", "Aesculap InOS" and "STERILIT I" are registered trademarks of Aesculap AG. "Sterrads 100 S", "Sterrads 200", "Sterrads NX" and "Sterrads 100 NX" are registered trademarks of ASP. "V-Pro 1" and "V-Pro 1 Plus" are registered trademarks of Steris. Subject to technical changes. All rights reserved. This brochure may only be used for the exclusive purpose of obtaining information about our products. Reproduction in any form partial or otherwise is not permitted.