

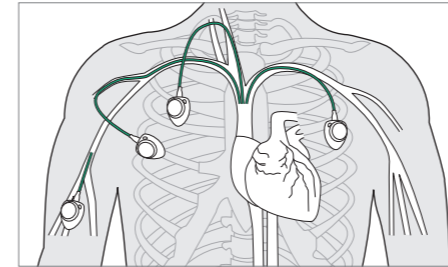

Celsite[®] and Surecan[®]

Venous access port systems
and non-coring port needles

Access Port Systems



Venous access

For repeated intra-venous administration of, for example, chemotherapy, antibiotics and anti-viral drugs, parenteral nutrition, blood sampling or transfusion.

Content

	Access Port Systems for venous access		Characteristics, MRI, CECT
4 - 7	Celsite® Safety Venous access ports for extended flexibility without compromise on safety	17	Celsite® MR compatibility and high pressure resistance
8 - 9	Celsite® Epoxy Premium venous access ports with special compact port design	18 - 19	Safety Access Port Needles Surecan® Safety II High pressure resistant non-coring safety needle for access ports
10 - 11	Celsite® ECG Venous access ports for accurate ECG guided catheter positioning		Access Port Needles Winged Surecan® High pressure resistant non-coring safety needle for access ports
12 - 13	Celsite® Discreet Venous access ports with unique design for enhanced port stability and better cosmetic results	20	
14 - 15	Celsite® PSU Venous access ports for mid to long-term venous applications	22	Celsite® Access Port Systems Celsite® Access Port Systems Recommended maximum flow rates
16	Celsite® Double Specialized venous access ports with two separate port chambers	23	Celsite® Access Port Systems Overview and type declaration
		24 - 26	Accessories

Celsite® Safety

Venous access ports for extended flexibility without compromise on safety



Celsite® Safety is intended to be used in any condition that requires mid to long-term intermittent or continuous central venous infusions. The anatomic design with a low profiled nose simplifies the insertion and allows the creation of a small port pocket to downsize the trauma.

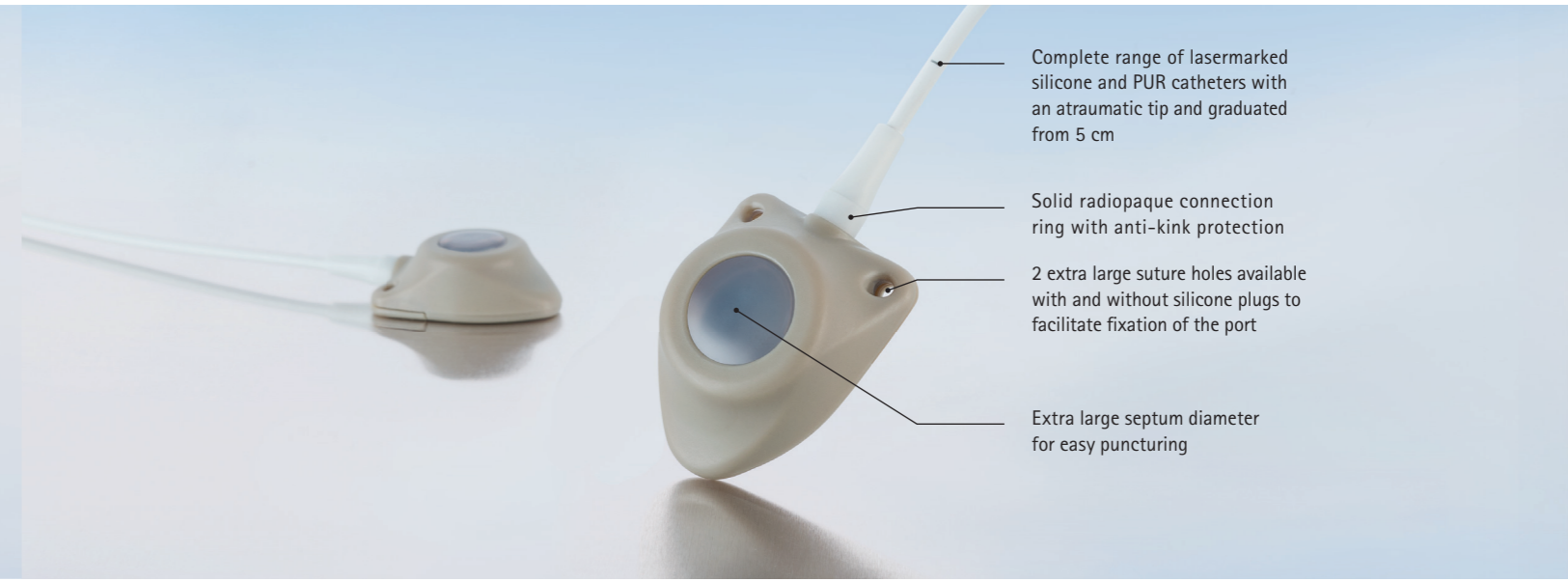

- Complete range of lasermarked silicone and PUR catheters with an atraumatic tip and graduated from 5 cm
- Solid radiopaque connection ring with anti-kink protection
- 2 extra large suture holes available with and without silicone plugs to facilitate fixation of the port
- Extra large septum diameter for easy puncturing

Reduced titanium content

To reduce metal induced artifacts in MRI

PEEK as housing and chamber material

- Poly Ether Ether Ketone - A biocompatible material with high chemical and pressure resistance and excellent durability characteristics.
- Natural color without any additional substances

Titanium bottom plate

High puncture resistance

Titanium exit cannula

Precision in catheter connection

High pressure resistant And Radiopaque CT - marking

- Complete range of Celsite® Safety is resistant to high pressure injections up to 325 psi
- Enables power injections of contrast media
- No need for additional venous access
- Clear identification of high pressure resistance under the X-ray

Large puncture area with high density silicone septum

For simple puncturing and reliable sealing to allow good port life

Extra large suture holes

For easy fixation of the access port with sutures

Lasermarked PUR and silicone catheters

- Clear readability of the catheter length
- No ink is added

Radiopaque connection ring

Anti kink protection and additional fixation of the catheter

PEEK and titanium combination as special safety features

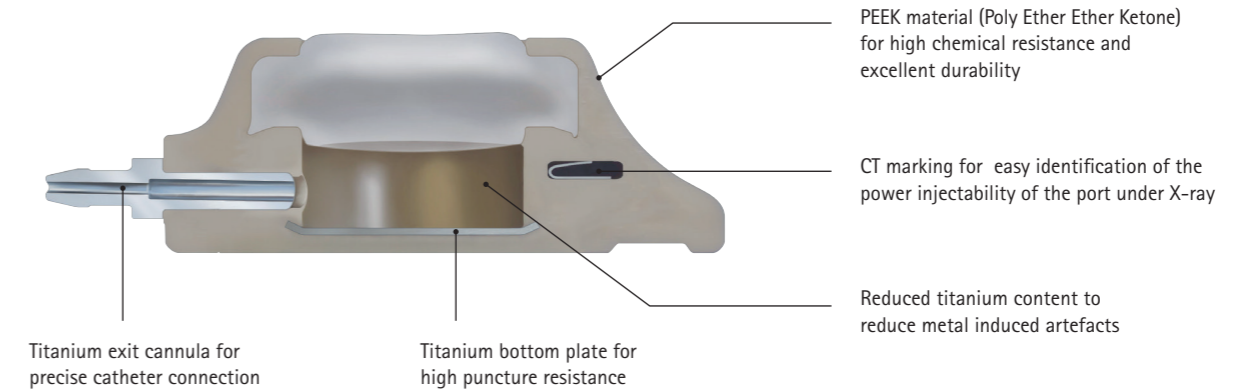

Titanium exit cannula for precise catheter connection

Titanium bottom plate for high puncture resistance

PEEK material (Poly Ether Ether Ketone) for high chemical resistance and excellent durability

CT marking for easy identification of the power injectability of the port under X-ray

Reduced titanium content to reduce metal induced artefacts

Surecan® Safety II - Port Needle

- Intuitive safety mechanism to reduce the risk of needle stick injuries
- High pressure resistance up to 325 psi

Safecan™ Safety - Puncture Needle

- Safety mechanism to reduce the risk of needle stick injuries
- Echogenic puncture needle for needle tip location via ultrasound

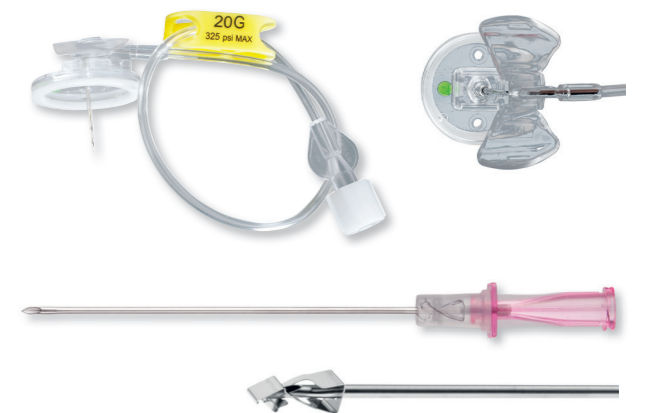

Power Injections

325 psi

Celsite® Safety

Celsite® Safety offers a wide range of Silicone and PUR catheters as well as two different port sizes, Standard and Small.

Celsite® Safety with open suture holes

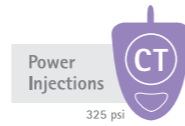

Catheter	OD (F/mm)	ID (mm)	Length (mm)	Flow rate* (ml/min)		Recommended maximum flow rates (mL/s) Contrast media at 37°C (325 psi = 22.4 bar)**			Implantation technique	Type	Reference	Accessories see page 32
				19 G	22 G	Viscosity up to 11.4 mPa.s (cP)						
						22 G	20 G	19 G				
Standard												
Silicone	6.5 / 2.2	1.1	500	26	10	2	5	5	Surgical cut-down	T601F	4437556	8
Silicone	8.5 / 2.8	1.2	500	34	11	2	5	5	Surgical cut-down	T601L	4437573	8
PUR	6.5 / 2.1	1.4	500	37	12	2	5	5	Surgical cut-down	T601P	4437565	8
PUR	8.5 / 2.8	1.6	500	48	12	2	5	5	Surgical cut-down	T601H	4437581	8
Silicone	6.5 / 2.2	1.1	500	26	10	2	5	5	Seldinger	SST601F	4437603	7
Silicone	8.5 / 2.8	1.2	500	34	11	2	5	5	Seldinger	SST601L	4437612	7
Silicone	10 / 3.2	1.6	500	48	12	2	5	5	Seldinger	SST601G	4437620	7
PUR	6.5 / 2.1	1.4	500	37	12	2	5	5	Seldinger	SST601P	4437607	7
PUR	8.5 / 2.8	1.6	500	48	12	2	5	5	Seldinger	SST601H	4437617	7
Small												
Silicone	6.5 / 2.2	1.1	500	26	10	2	5	5	Surgical cut-down	T605F	4437758	8
Silicone	10 / 3.2	1.6	500	48	12	2	5	5	Surgical cut-down	T605G	4437786	8
Silicone	6.5 / 2.2	1.1	500	26	10	2	5	5	Seldinger	SST605F	4437803	7
Silicone	8.5 / 2.8	1.2	500	34	11	2	5	5	Seldinger	SST605L	4437817	7
Silicone	10 / 3.2	1.6	500	48	12	2	5	5	Seldinger	SST605G	4437822	7
PUR	5 / 1.6	1.1	500	26	10	2	5	5	Seldinger	SST605C	4437800	7
PUR	6.5 / 2.1	1.4	500	37	12	2	5	5	Seldinger	SST605P	4437809	7
PUR	8.5 / 2.8	1.6	500	48	12	2	5	5	Seldinger	SST605H	4437813	7

*Gravity infusion of saline (0.9 %) through a 22G respectively 19G needle from a height difference of 1 m and a catheter length of 40 cm. According to ISO 10555-1.
**Flow rates determined according to ISO 10555-6 with a catheter of 20 cm and Surecan® Safety II 20 mm needle

All Celsite® Safety Ports are PVC, LATEX and DEHP free

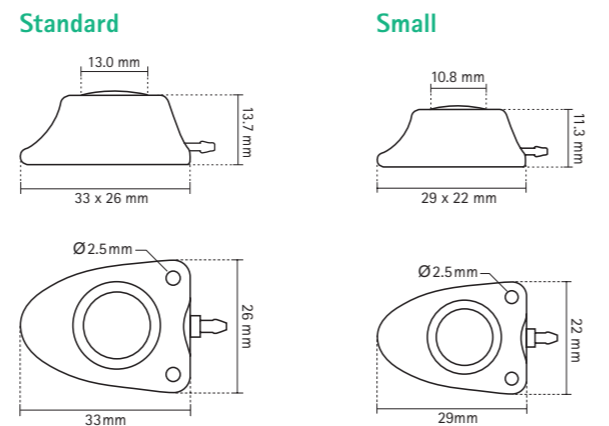

Material:	Titanium PEEK	Material:	Titanium PEEK
Weight:	8 g	Weight:	5 g
Internal Volume:	0.5 mL	Internal Volume:	0.3 mL

Celsite® Safety

Additional References with Silicone Plugs

Celsite® Safety with Silicone plugs

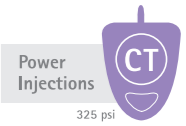

Catheter	OD (F/mm)	ID (mm)	Length (mm)	Flow rate* (ml/min)		Recommended maximum flow rates (mL/s) Contrast media at 37°C (325 psi = 22.4 bar)**			Implantation technique	Type	Reference	Accessories see page 32
				19 G	22 G	Viscosity up to 11.4 mPa.s (cP)						
						22 G	20 G	19 G				
Standard												
Silicone	6.5 / 2.2	1.1	500	26	10	2	5	5	Seldinger	SST701F	4437605	7
Silicone	8.5 / 2.8	1.2	500	34	11	2	5	5	Seldinger	SST701L	4437614	7
Silicone	10 / 3.2	1.6	500	48	12	2	5	5	Seldinger	SST701G	4437621	7
PUR	6.5 / 2.1	1.4	500	37	12	2	5	5	Seldinger	SST701P	4437609	7
Silicone	6.5 / 2.2	1.1	500	26	10	2	5	5	Surgical cut-down	T701F	4437560	8
Silicone	8.5 / 2.8	1.2	500	34	11	2	5	5	Surgical cut-down	T701L	4437578	8
Small												
Silicone	6.5 / 2.2	1.1	500	26	10	2	5	5	Seldinger	SST705F	4437805	7
Silicone	8.5 / 2.8	1.2	500	34	11	2	5	5	Seldinger	SST705L	4437818	7
Silicone	10 / 3.2	1.6	500	48	12	2	5	5	Seldinger	SST705G	4437790	7
PUR	5 / 1.6	1.1	500	26	10	2	5	5	Seldinger	SST705C	4437801	7
PUR	6.5 / 2.1	1.4	500	37	12	2	5	5	Seldinger	SST705P	4437807	7
PUR	8.5 / 2.8	1.6	500	48	12	2	5	5	Seldinger	SST705H	4437815	7

*Gravity infusion of saline (0.9 %) through a 22G respectively 19G needle from a height difference of 1 m and a catheter length of 40 cm. According to ISO 10555-1
**Flow rates determined according to ISO 10555-6 with a catheter of 20 cm and Surecan® Safety II 20 mm needle

Celsite® Epoxy

Premium venous access ports with special compact port design

As the premium access port range of B. Braun, Celsite® Epoxy ports offer outstanding features as well as an extended portfolio of different port sizes and catheters.

They are intended to be used for repeated, intravenous administration of, for example, chemotherapy, antibiotic and anti-viral drugs, parenteral nutrition, blood sampling or transfusion.

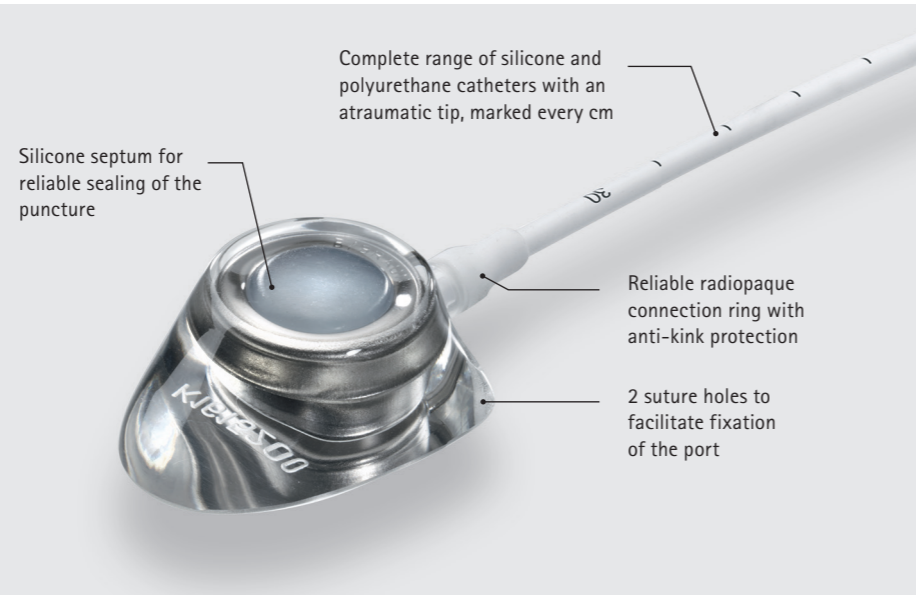

Highly compact design

Celsite® Epoxy ports have an extremely low profile and related to the total dimensions of the port a particularly large septum.



High pressure resistant

The complete range of venous Celsite® Epoxy ports is resistant to high pressure injection up to 325 psi. This enables for power injections of contrast media in radiology, without the need for additional access and needlesticks.

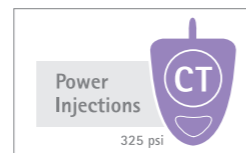

Radiopaque CT Marking

Celsite® Epoxy offers radiopaque CT marking. With CT marking it is possible to identify the port as resistant to high pressure injection in the X-ray image.



Extended Portfolio

Available as extra small Brachial- and Babyport®. One of the most compact access ports commercially available.

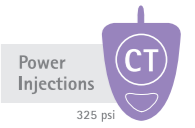

Catheter	OD (F/mm)	ID (mm)	Length (mm)	Flow rate* (ml/min)	325 PSI Recommended maximum flow rates (mL/s) Contrast media at 37°C (325 psi = 22.4 bar)**						Implantation technique	Type	Reference	Accessories see page 30/31	
					Viscosity 5.8 mPa.s (cP)			Viscosity 11.4 mPa.s (cP)							
					19G	22G	22G	20G	19G	22G					20G
Standard															
PUR	5 / 1.6	1.1	900	24	10	2	5	6	2	5	6	Seldinger	ST201C	04432045	1
Silicone	6.5/2.2	1.1	800	26	10	2	6	7	2	6	8	Surgical cut-down	T201F	04430034	6
Silicone	6.5/2.2	1.1	800	26	10	2	6	7	2	6	8	Seldinger	ST201F	04430409	1
PUR	6.5/2.1	1.4	800	34	11	2	5	7	2	5	6	Seldinger	ST201P	04430417	1
PUR (high flow)	8.5/2.8	1.6	800	45	12	2	6	8	2	7	9	Seldinger	ST201H	04433149	1
Silicone	8.5/2.8	1.1	800	28	13	2	6	7	2	6	9	Surgical cut-down	T201	04430026	6
Silicone	8.5/2.8	1.1	800	28	13	2	6	7	2	6	9	Seldinger	ST201	04430395	1
Silicone (high flow)	10 / 3.2	1.6	800	47	13	2	6	9	2	6	8	Seldinger	ST201G	04433807	1
Small															
Silicone	6.5/2.2	1.1	800	24	10	2	5	8	2	5	6	Seldinger	ST205	04430893	1
Silicone	6.5/2.2	1.1	800	24	10	2	5	8	2	5	6	Surgical cut-down	T205	04430085	6
PUR	6.5/2.1	1.4	800	30	11	2	5	8	2	5	6	Seldinger	ST205P	04430894	1
Silicone	8.5/2.8	1.1	800	25	10	2	5	8	2	5	7	Seldinger	ST205L	04430895	1
PUR (high flow)	8.5/2.8	1.6	800	37	12	2	6	9	2	5	8	Seldinger	ST205H	04436806	1
Silicone***	6.5/2.2	1.0	800	24	10	2	5	8	2	5	6	Seldinger	ST215	04430143	1
Baby/Brachial															
PUR	4.5 / 1.5	0.8	800	12	7	2	4	-	2	3	-	Seldinger	Babyport®	04433742	4
PUR	5 / 1.6	1.1	700	22	10	2	5	-	2	4	-	Seldinger, OTW	Brachial	04433734	10
Silicone	6 / 2.0	1.2	600	24	10	2	5	-	2	5	-	Seldinger	Babyport® S	04433842	5

Celsite® Epoxy offers a wide range of Silicone and PUR catheters and three different port sizes, Standard, Small and Baby/Brachial.

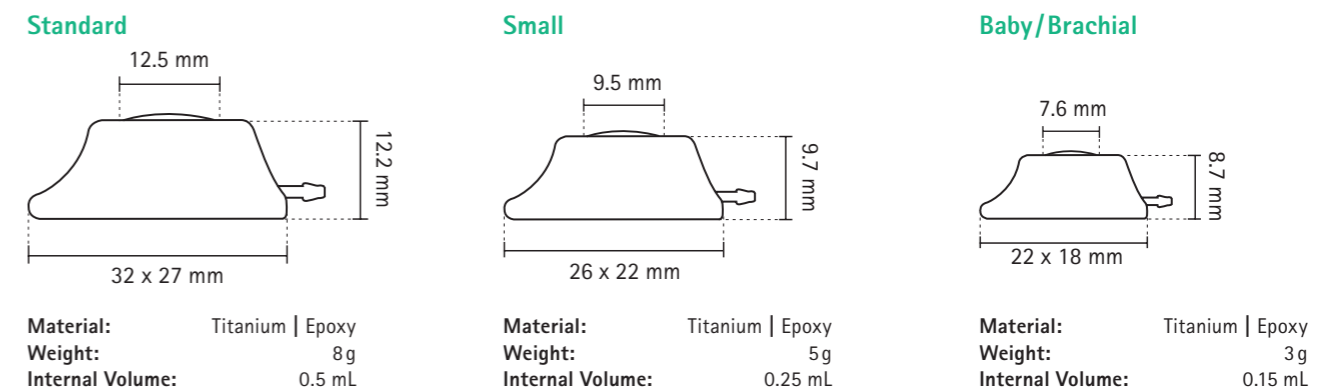

*Gravity flow rates established by gravity infusion of NaCl 0.9 %, height 1 m. Catheter length 40 cm. According to ISO 10555-1.

**With a catheter of 20 cm and Surecan® Safety II. For countries under CE mark only.

***With pre-connected catheter.

Celsite® ECG

Venous access ports for accurate ECG guided catheter positioning

- Celsite® ECG allows catheter positioning via intra-atrial ECG detection
- Accurate placement of the catheter tip into the superior vena cava without intraoperative fluoroscopy
- With radiopaque CT marking.

Correct and accurate positioning of the catheter is of high importance to reduce the risk of long term complications.*



*Caers J., Support Care Cancer (2005) 13:325–331

Accepted

Proven in daily clinical routine and numerous clinical trials.

Accurate

Celsite® ECG allows accurate placement of the catheter tip.

Without X-ray

No expensive X-ray equipment needed in almost all cases. No X-ray exposure for theatre staff and patients.

Compatible

Celsite® ECG can be used with any ECG monitor with no need for additional investment.

The Certodyn® Universal Adapter can be ordered by reference 04150228

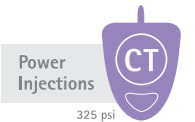

Catheter	OD (F/mm)	ID (mm)	Length (mm)	Flow rate* (ml/min)		325 PSI Recommended maximum flow rates (mL/s) Contrast media at 37°C (325 psi = 22.4 bar)**						Implantation technique	Type	Reference	Accessories see page 30/31
						Viscosity 5.8 mPa.s (cP)			Viscosity 11.4 mPa.s (cP)						
						19 G	22 G	22 G	20 G	19 G	22 G				
Standard															
Silicone	6.5 / 2.2	1.0	500	26	10	2	6	7	2	6	8	Seldinger	ST201F ECG	04440140	9
Silicone	6.5 / 2.2	1.0	500	26	10	2	6	7	2	6	8	Surgical cutdown	T201F ECG	04440150	14
Silicone	8.5 / 2.8	1.1	500	28	13	2	6	7	2	6	9	Seldinger	ST201 ECG	04430140	9
Silicone	8.5 / 2.8	1.1	500	28	13	2	6	7	2	6	9	Surgical cutdown	T201 ECG	04430150	14
Small															
Silicone	6.5 / 2.2	1.0	500	24	10	2	5	8	2	5	6	Seldinger	ST205F ECG	04440111	9
Silicone	6.5 / 2.2	1.0	500	24	10	2	5	8	2	5	6	Surgical cutdown	T205F ECG	04440222	14
Silicone	8.5 / 2.8	1.1	500	25	10	2	5	8	2	5	7	Seldinger	ST205 ECG	04430111	9
Silicone	8.5 / 2.8	1.1	500	25	10	2	5	8	2	5	7	Surgical cutdown	T205 ECG	04430222	14

Localisation

- 1 Maximal P-wave height is reached and maintained when the catheter enters into the right atrium. After identifying the area where the P-wave begins to develop its maximal amplitude (which corresponds anatomically to the junction between superior vena cava and the right atrium) advance the catheter a further 2 cm.
- 2 This is the final position of the catheter tip with the patient in supine position. This catheter position allows for the 2-3 cm cranial movement of the catheter tip which occurs when the patient is upright.

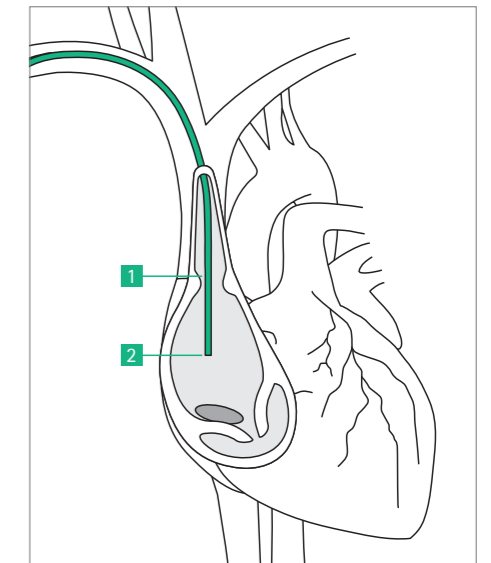

Standard

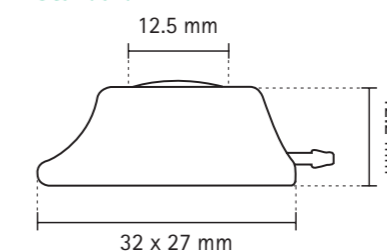

Material: Titanium | Epoxy
Gewicht: 8g
Reservoir: 0.5 mL

Small

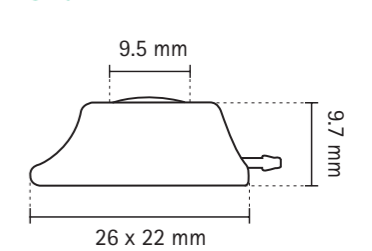

Material: Titanium | Epoxy
Gewicht: 5g
Reservoir: 0.25 mL

*Gravity flow rates established by gravity infusion of NaCl 0.9 %, height 1 m. Catheter length 40 cm. According to ISO 10555-1.

**With a catheter of 20 cm and Surecan® Safety II. For countries under CE mark only.

Celsite® Discreet

Venous access ports with unique design for enhanced port stability and better cosmetic results

Celsite® Discreet offers unique design and allows better cosmetic results for the patient.

- The low profile design with patented 90° connection provides a high level of discretion
- Also available in small size to facilitate implantation in paediatric and underweight patients
- MR conditional, Latex, DEHP and PVC free
- With radiopaque CT marking.



Prevention of Port Flip

Patented 90° angle of the exit cannula reduces the risk of port flip and associated blockage due to catheter kinking

Better Cosmetic Results

The surgical incision can be made vertically and placed laterally following the subcutaneous traction lines

High pressure resistant

The complete range of venous Celsite® Epoxy ports is high pressure resistant up to 325 psi. This enables for power injections of contrast media in radiology, without the need for additional access and needlesticks.

Radiopaque CT Marking

Celsite® Epoxy offers radiopaque CT marking. With CT marking it is possible to identify the port as high pressure resistant in the X-ray image.

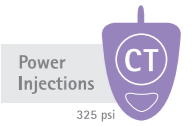

Catheter	Exit can-nula	OD (F/mm)	ID (mm)	Length (mm)	Flow rate* (ml/min)		325 PSI Recommended maximum flow rates (mL/s) Contrast media at 37°C (325 psi = 22.4 bar)**						Implantation technique	Type	Reference	Accesso-ries see page 30/31
					19G	22G	Viscosity 5.8 mPa.s (cP)			Viscosity 11.4 mPa.s (cP)						
Standard																
Silicone	left	8.5/2.8	1.1	800	28	13	2	6	7	2	6	9	Seldinger	STL201L	04430144	1
Silicone	right	8.5/2.8	1.1	800	28	13	2	6	7	2	6	9	Seldinger	STR201L	04430145	1
PUR	left	8.5/2.8	1.6	800	45	12	2	6	8	2	7	9	Seldinger	STL201H	04440201	1
PUR	right	8.5/2.8	1.6	800	45	12	2	6	8	2	7	9	Seldinger	STR201H	04440202	1
Small																
Silicone	left	6.5/2.2	1.1	800	24	10	2	5	8	2	5	6	Seldinger	STL205F	04430146	1
Silicone	right	6.5/2.2	1.1	800	24	10	2	5	8	2	5	6	Seldinger	STR205F	04430147	1
PUR	left	6.5/2.1	1.4	800	30	11	2	5	8	2	5	6	Seldinger	STL205P	04440203	1
PUR	right	6.5/2.1	1.4	800	30	11	2	5	8	2	5	6	Seldinger	STR205P	04440204	1

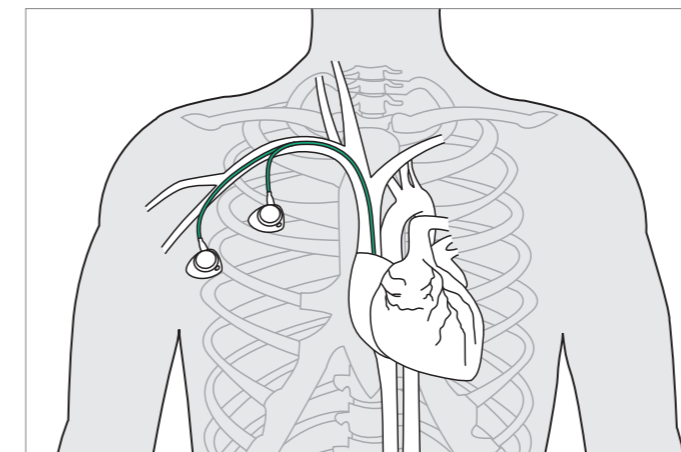

Standard and lateral placement of Celsite® Discreet with vertical incision.



CT-Marking of Celsite® Discreet

Standard

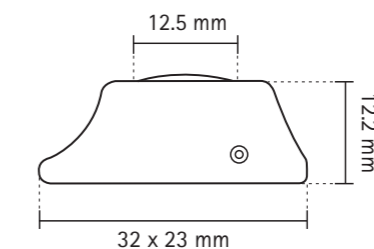

Material: Titanium | Epoxy
Weight: 7g
Internal Volume: 0.5 mL

Small

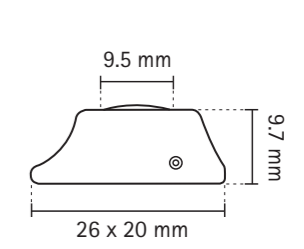

Material: Titanium | Epoxy
Weight: 4g
Internal Volume: 0.25 mL

*Gravity flow rates established by gravity infusion of NaCl 0.9 %, height 1 m. Catheter length 40 cm. According to ISO 10555-1.

**With a catheter of 20 cm and Surecan® Safety II. For countries under CE mark only.

Celsite® PSU

Venous access ports for mid to long-term venous applications

Celsite® PSU ports are the standard venous access port range for any condition that requires mid to long-term intermittent or continuous central venous infusions.

This might include chemotherapy, antibiotic and anti-viral drugs, parenteral nutrition, blood sampling or transfusion.

Celsite® PSU has a polysulphone body with a titanium chamber and is high pressure resistant up to 325 psi (22.4 bar).

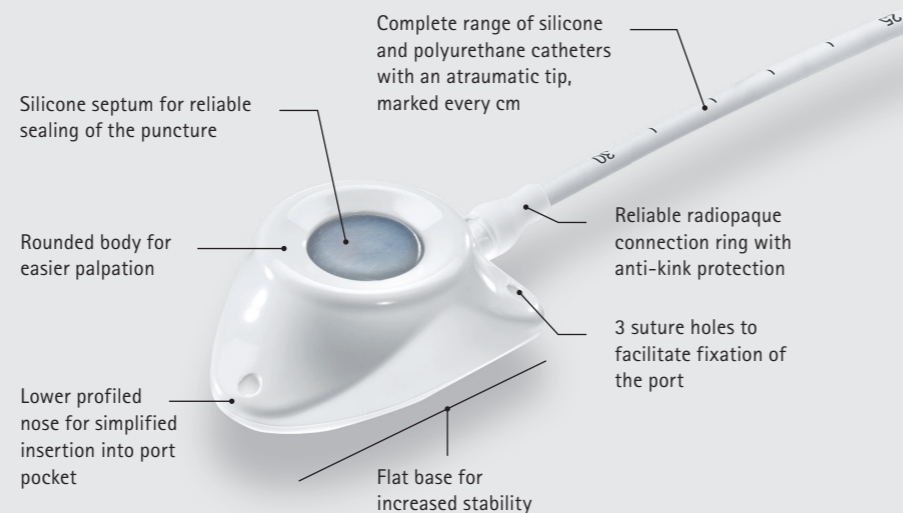

- Anatomic design and lower profiled nose for simplified insertion and patient comfort
- Available in standard and small size
- 3 suture holes to facilitate fixation of the port
- Large range of silicone and polyurethane catheters
- The radiopaque catheter is graduated from 5 cm in order to facilitate an easy, precise and reliable implantation
- MRI-conditional, Latex, DEHP and PVC free
- Resistant to high pressure injection up to 325 PSI (22.4 bar)

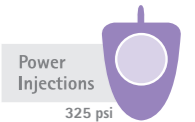

Catheter	OD (F/mm)	ID (mm)	Length (mm)	Flow rate* (ml/min)		325 PSI Recommended maximum flow rates (mL/s) Contrast media at 37°C (325 psi = 22.4 bar)**						Implantation technique	Type	Reference	Accessories see page 30/31	
				19 G	22 G	Viscosity 5.8 mPa.s (cP)			Viscosity 11.4 mPa.s (cP)							
						22 G	20 G	19 G	22 G	20 G	19 G					
Standard																
PUR	5 /1.6	1.1	900	24	10	2	5	6	2	5	6	Seldinger	ST301C	04432096	2	
PUR	5 /1.6	1.1	370	24	10	2	5	6	2	5	6	OTW	ST301OTW	04433726	6	
PUR	6.5/2.1	1.4	800	34	11	2	5	7	2	5	6	Seldinger	ST301P	04430441	1	
PUR	6.5/2.1	1.4	800	34	11	2	5	7	2	5	6	Surgical cut-down	T301P	04430387	6	
Silicone	6.5/2.2	1.0	800	26	10	2	6	7	2	6	8	Seldinger	ST301F	04430433	1	
Silicone***	6.5/2.2	1.0	800	26	10	2	6	7	2	6	8	Seldinger	ST311F	04436717	1	
Silicone	6.5/2.2	1.0	800	26	10	2	6	7	2	6	8	Surgical cut-down	T301F	04430000	6	
Silicone	8.5/2.8	1.1	800	28	13	2	6	7	2	6	9	Seldinger	ST301	04430425	1	
Silicone***	8.5/2.8	1.1	800	28	13	2	6	7	2	6	9	Seldinger	ST311	04436709	1	
Silicone	8.5/2.8	1.1	800	28	13	2	6	7	2	6	9	Surgical cut-down	T301	04430018	6	
PUR (high flow)	8.5/2.8	1.6	800	45	12	2	6	8	2	7	9	Seldinger	ST301H	04432460	1	
PUR (high flow)	8.5/2.8	1.6	800	45	12	2	6	8	2	7	9	Surgical cut-down	T301H	04432452	6	
PUR (high flow)***	8.5/2.8	1.6	800	45	12	2	6	8	2	7	9	Seldinger	ST311H	04436814	1	
Silicone (high flow)	10 /3.2	1.6	800	47	13	2	6	9	2	6	8	Seldinger	ST301G	04433823	1	
Small																
PUR	5 /1.6	1.1	900	22	10	2	5	7	2	5	6	Seldinger	ST305C	04436962	2	
PUR	6.5/2.1	1.4	800	30	11	2	5	8	2	5	6	Seldinger	ST305P	04436946	1	
Silicone	6.5/2.2	1.0	800	24	10	2	5	8	2	5	6	Seldinger	ST305	04433750	1	
Silicone***	6.5/2.2	1.0	800	24	10	2	5	8	2	5	6	Seldinger	ST315	04436725	1	
Silicone	6.5/2.2	1.0	800	24	10	2	5	8	2	5	6	Surgical cut-down	T305	04436903	6	
Silicone	8.5/2.8	1.1	800	25	10	2	5	8	2	5	7	Seldinger	ST305L	04436920	1	
Silicone***	8.5/2.8	1.1	800	25	10	2	5	8	2	5	7	Seldinger	ST315L	04436710	1	
PUR (high flow)	8.5/2.8	1.6	800	37	12	2	6	9	2	5	8	Seldinger	ST305H	04433556	1	

Celsite® PSU ports offer a wide range of silicone and PUR catheters combined with two different port sizes, Standard and Small.

Standard

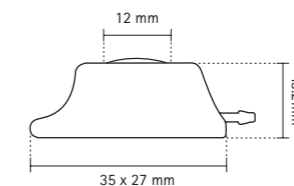

Material: Titanium | Polysulphone
Weight: 9g
Internal Volume: 0.5 mL

Small

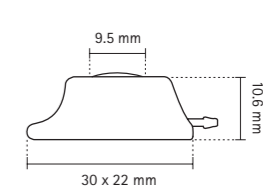

Material: Titanium | Polysulphone
Weight: 4.7g
Internal Volume: 0.25 mL

*Gravity flow rates established by gravity infusion of NaCl 0.9 %, height 1 m. Catheter length 40 cm. According to ISO 10555-1.

**With a catheter of 20 cm and Surecan® Safety II. For countries under CE mark only.

***With pre-connected catheters.

Celsite® Double

Specialized venous access ports with two separate port chambers for simultaneous infusion

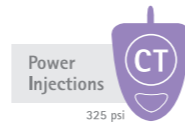

- For simultaneous infusion of e.g. incompatible drugs
- For infusion with high flow rates by using both lumina
- Administration of continuous infusion and bolus injection
- Alternating puncture sites
- Profiled shape to be easily placed in a small pocket
- Small size facilitates implantation in paediatric and underweight patients
- Off-set silicone catheter tip ensures that no mixing of drugs occurs at the catheter tip
- With radiopaque CT marking



Celsite®

MR Compatibility and High Pressure Resistance

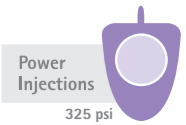

Catheter	OD (F/mm)	ID (mm)	Length (mm)	Flow rate* (ml/min)		325 PSI Recommended maximum flow rates (mL/s) Contrast media at 37°C (325 psi = 22.4 bar)						Implantation technique	Type	Reference	Accessories see page 30/31	
				19G	22G	Viscosity 5.8 mPa.s (cP)			Viscosity 11.4 mPa.s (cP)							
Standard																
Silicone	10/3.2	1.2 x 2	800	32	11	2	5	8	2	6	9	Seldinger	ST401L	04430100	1	
Small																
Silicone	10/3.2	1.2 x 2	800	29	11	2	5	8	2	5	7	Seldinger	ST405L	04430101	1	

Standard

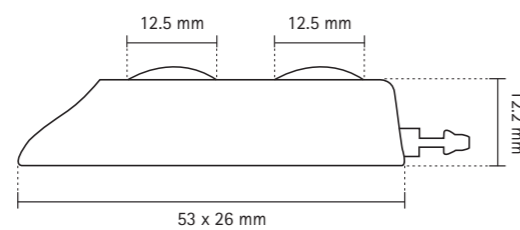

Material: Titanium | Epoxy
Weight: 14g
Internal Volume: 0.5 mL x 2

Small

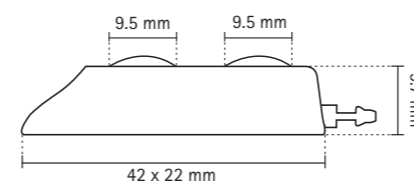

Material: Titanium | Epoxy
Weight: 7.5g
Internal Volume: 0.25 mL x 2

MR-Conditional Celsite® Access Ports

Non-clinical testing demonstrated that Celsite® Access Ports are MR Conditional. A patient with these devices can be scanned immediately after placement under the following conditions:

- Static magnetic field of 3-Tesla and 1.5-Tesla
- Maximum spatial gradient magnetic field of 4000 (extrapolated) Gauss/cm or less
- Maximum whole body averaged specific absorption rate (SAR) of 2 W/kg for 15 minutes of scanning (i.e., per pulse sequence) in the normal operating mode of operation for the MR system.

MR-Conditional Surecan® and Cytocan® port needles

Non-clinical testing demonstrated that Surecan®/Cytocan® port needles are MR Conditional. A patient with these devices can be scanned immediately after placement under the following conditions:

- Static magnetic field of 3-Tesla and 1.5-Tesla
- Maximum spatial gradient magnetic field of 710 Gauss/cm or less
- Maximum whole body averaged specific absorption rate (SAR) of 2.9 W/kg for 15 minutes of scanning

MR image quality may be compromised if the area of interest is in the exact same area or relatively close to the position of the devices. Therefore, optimization of MR imaging parameters to compensate for the presence of these devices may be necessary.

Please see instructions for use for general information and information on MRI-related heating.

Pressure Resistance

All venous Celsite® Access Ports with titanium chamber or a titanium plate are resistant to high pressure injection up to 325 psi / 22.4 bar.

Please see instructions for use for detailed device information regarding high pressure injection.

Material

All Celsite® Access Ports are latex-, PVC- and DEHP-free. All Surecan® needles are latex- and DEHP-free.

LATEX FREE	PVC FREE	DEHP FREE
---------------	-------------	--------------

*Gravity flow rates established by gravity infusion of NaCl 0.9 %, height 1 m. Catheter length 40 cm. According to ISO 10555-1.
 **With a catheter of 20 cm and Surecan® Safety II. For countries under CE mark only.

Surecan® Safety II

High pressure resistant non-coring safety needle for access ports

Surecan® Safety II is the power injectable access port needle with an easy to use safety mechanism for reduced risk of needlestick injuries.

The small size and innovative design of Surecan® Safety II enables comfort for both clinicians and patients, either in hospital or for home care treatment.



User safety

Intuitive safety mechanism for reduced risk of needlestick injuries

Patient comfort

Low profile and foam pad for better patient comfort

Easy removal

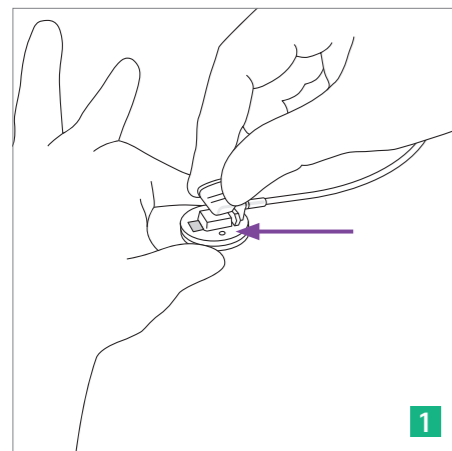

Stabilise the needle base on the port

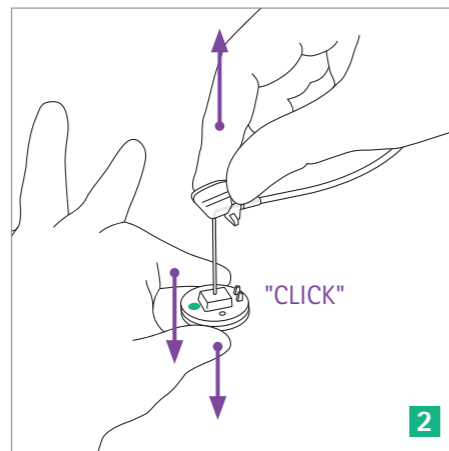

Firmly pull the wings up until you hear a "Click"

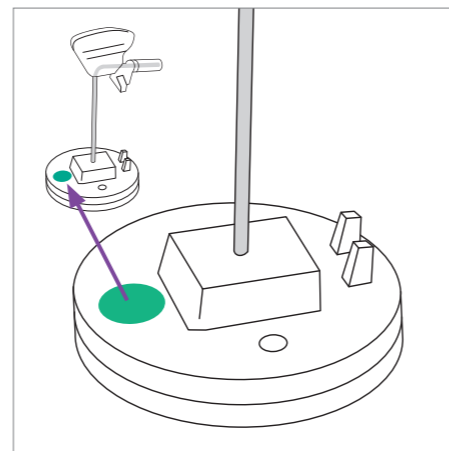

Green dot and audible click clearly indicate the safety mechanism was executed

Handling

Flexible and ergonomic wings for reliable handling

Power injections

Suitable for power injections up to 325 psi

Surecan® Safety II

High pressure resistant non-coring safety needle for access ports

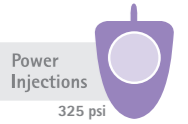

Surecan® Safety II non-coring safety needle

- tubing length cannula to connector: 200 mm



Size	Cannula diameter (mm)	Cannula length (mm)	Sales unit (pcs.)	Reference
G 19	1.1	12	20	04447042
G 19	1.1	15	20	04447000
G 19	1.1	20	20	04447001
G 19	1.1	25	20	04447002
G 19	1.1	32	20	04447003
G 19	1.1	38	20	04447004
G 20	0.9	12	20	04447043
G 20	0.9	15	20	04447005
G 20	0.9	20	20	04447006
G 20	0.9	25	20	04447007
G 20	0.9	32	20	04447008
G 20	0.9	38	20	04447009
G 22	0.7	12	20	04447044
G 22	0.7	15	20	04447010
G 22	0.7	20	20	04447011
G 22	0.7	25	20	04447012
G 22	0.7	32	20	04447013

Surecan® Safety II non-coring safety needle with pre-connected Caresite® and Y-site

- Y-site configuration
- tubing length Y-site to connector: 98 mm
- tubing length cannula to Y-site: 105 mm
- Caresite® is a needle-free, positive pressure valve which reduces the risk of blood reflux



Size	Cannula diameter (mm)	Cannula length (mm)	Sales unit (pcs.)	Reference
G 19	1.1	12	20	04447057
G 19	1.1	15	20	04447045
G 19	1.1	20	20	04447046
G 19	1.1	25	20	04447047
G 19	1.1	32	20	04447048
G 19	1.1	38	20	04447049
G 20	0.9	12	20	04447058
G 20	0.9	15	20	04447050
G 20	0.9	20	20	04447051
G 20	0.9	25	20	04447052
G 20	0.9	32	20	04447053
G 22	0.7	12	20	04447059
G 22	0.7	15	20	04447054
G 22	0.7	20	20	04447055
G 22	0.7	25	20	04447056

- Non-absorbant closed-cell foam pad of the patient plate
- MR conditional, Latex and DEHP free

LATEX
FREE

DEHP
FREE

Winged Surecan®

Access Port Needles

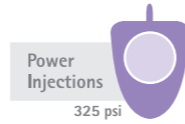

Winged Surecan® non-coring needle

- use for long-term infusions
- high pressure resistant up to 325 psi (22.4 bar)
- flexible wings for easier puncture and fixation
- latex- and DEHP-free
- extension tubing with clamp
- tubing length cannula to connector: 200 mm



Size	Cannula diameter (mm)	Cannula length (mm)	Sales unit-pcs.	Reference
19G	1.1	15	15	04448286
19G	1.1	20	15	04448294
19G	1.1	25	15	04448308
20G	0.9	15	15	04448332
20G	0.9	20	15	04448340
20G	0.9	25	15	04448359
20G	0.9	30	15	04448367
22G	0.7	12	15	04448375
22G	0.7	15	15	04448383
22G	0.7	20	15	04448391
22G	0.7	25	15	04448405

Winged Surecan® non-coring needle with Y-site

- use for long-term infusions
- flexible wings for easier puncture and fixation
- latex- and DEHP-free
- tubing length Y-site to connector: 98 mm
- tubing length cannula to Y-site: 105 mm
- Y-site configuration



Size	Cannula diameter (mm)	Cannula length (mm)	Sales unit-pcs.	Reference
19G	1.1	20	15	04448430
19G	1.1	25	15	04448448
20G	0.9	15	15	04448472
20G	0.9	20	15	04448480
20G	0.9	25	15	04448499
22G	0.7	15	15	04448529
22G	0.7	20	15	04448537
22G	0.7	25	15	04448545
22G	0.7	30	15	04448553



Celsite® Access Port Systems

Recommended maximum flow rates (ML/S)

with Surecan® Safety II and Winged Surecan® needle without Y-site (except Celsite® Safety)



Recommended maximum flow rates (mL / s) with a catheter of 20 cm and contrast media at 37° C (98.6 F)

		Viscosity 5,8 mPa.s (cP)** (4)			Viscosity 11,4 mPa.s (cP)** (5)		
		Winged / Angled Surecan® needle (7) / Surecan® Safety II			Winged / Angled Surecan® needle (7) / Surecan® Safety II		
		22 G	20 G	19 G	22 G	20 G	19 G
Baby Size Port	Babyport®	2	4	-	2	3	-
	Brachial	2	5	-	2	4	-
	Babyport® S	2	5	-	2	5	-
Double port (9)	ST405L	2	5	8	2	5	7
	ST401L	2	5	8	2	6	9
Small Size Port (10)	ST305C	2	5	7	2	5	6
	STL205P - STR205P - ST305P - ST205P - BT305P	2	5	8	2	5	6
	T/ST305 - T/ST205 - SNT305F - ST315 - ST215-T/ST205F ECG - SNT215F - STL205F - STR205F	2	5	8	2	5	6
	ST305L - T/ST205ECG - ST205L - ST315L	2	5	8	2	5	7
	ST305H - ST205H	2	6	9	2	5	8
Standard Size Port (11)	ST301C - ST201C - ST3010TW	2	5	6	2	5	6
	T/ST301P - ST201P	2	5	7	2	5	6
	T/ST201F - T/ST201F ECG - SNT201F - T/ST301F - ST311F - SNT301F	2	6	7	2	6	8
	T/ST201 - T/ST201ECG - T/ST301-ST311 - STL201L - STR201L	2	6	7	2	6	9
	ST201H - T/ST301H - ST311H - STL201H - STR201H	2	6	8	2	7	9
ST301G - ST201G	2	6	9	2	6	8	

Recommended maximum pressure (CT function) - 325 psi (22.4 bar)

Flow rates may vary depending on temperature of contrast media and length of the implanted catheter.

Flow rates established with a catheter of 20 cm.

Celsite® Access Port Systems

Portfolio overview and type declaration

Indication	Catheter	OD	Catheter material	Access Port type	Dead volume port	Dead volume catheter (mL/cm)				
Venous	Small catheters	5 F	Polyurethane	ST201C	0.50 mL	0.010 mL				
				ST301C, ST3010TW	0.50 mL					
				ST305C	0.25 mL					
				4430263, 4438604	0.33 mL					
				4438647	0.15 mL					
	Small catheters	6.5 F	Polyurethane	SST605C	0.30 mL	0.009 mL				
				ST201P, T301P, ST301P	0.50 mL	0.015 mL				
				ST305P, STL205P, STR205P	0.25 mL					
				T601P, SST601P	0.50 mL					
				SST605P	0.30 mL					
	Large and high flow catheters	8.5 F	Silicone	T201F, ST201F, T301F, ST301F, ST311F*, ST201F ECG	0.50 mL		0.008 mL			
				T205, ST205, ST215*, T305, ST305, ST315*	0.25 mL	0.009 mL				
				T601F, SST601F	0.50 mL					
				T605F, SST605F	0.30 mL					
				T201, ST201, T301, ST301, ST311*, STL201L, STR201L	0.50 mL		0.010 mL			
Large and high flow catheters	8.5 F	Silicone	ST305L	0.25 mL	0.011 mL					
			T601L, SST601L	0.50 mL						
			SST605L	0.30 mL						
			ST201H, T301H, ST301H, ST311H*, STL201H, STR201H	0.50 mL		0.020 mL				
			ST305H	0.25 mL						
T601H, SST601H	0.50 mL									
Speciality venous	Small catheters	4.5 F	Polyurethane	Babyport®	0.15 mL		0.005 mL			
				5 F	Polyurethane		Brachial	0.15 mL	0.010 mL	
						6 F	Silicone	Babyport® S	0.15 mL	0.011 mL
								6.5 F	Silicone	STR205F, STL205F, ST205F ECG
				Large and high flow catheters	8.5 F	Silicone	STR201L, STL201L, ST201 ECG	0.50 mL	0.010 mL	
ST205ECG	0.25 mL									
Double port catheters	10 F	Silicone	ST401L	0.50 mL x 2	0.013 mL					
			ST405L	0.25 mL x 2						

Type Declaration:

Accessories	Exit Cannula Orientation	Housing Material / Suture Holes	Connection	Indication	Catheter	Technique
SST = Safety Seldinger Equipment ST = Seldinger Equipment T = Surgical Cut-Down	R = right cannula exit L = left cannula exit	2 = Epoxy housing 3 = PSU housing w. empty suture holes 4 = Epoxy Double housing 5 = PSU housing w. Silicone suture areas 6 = PEEK housing w. suture holes 7 = PEEK housing with silicone plugs	0 = w. separate connection rings 1 = pre connected	1 = Venous (std) 2 = Arterial 3 = Peritoneal Et pleural 4 = Spinal 5 = Venous (small)	C = PUR; 5F F = Si; 6.5F L = Si; 8.5F P = PUR; 6.5F H = PUR; 8.5F G = Si; 10F V = Si Valved; 7.5F	OTW = Over the Wire ECG = ECG implantation technique

Accessories

Venous accessories				
Pieces	Implantation technique	Percutaneous		
		Seldinger	OTW	Seldinger
	Kit designation	Kit 1	Kit 3	Kit 2
2	A Straight Surecan® needles	22 G x 30 mm	22 G x 30 mm	22 G x 30 mm
1	B Vein lifter	x	x	x
1	C Puncture needle	18 G x 70 mm	18 G x 70 mm	18 G x 70 mm
1	E J guide wire with dispenser	0.035" x 50 cm	0.035" x 70 cm	0.035" x 50 cm
1	F Dilator		6F x 100 mm	
1	G Tear-away introducer	L 180/140 mm		L 180/140 mm
1	H Tunnelling rod	x	x	x
1	I Omnifix luer syringe	10 mL	10 mL	10 mL
1	J Winged Surecan® needle	20 G x 20 mm	20 G x 20 mm	20 G x 20 mm

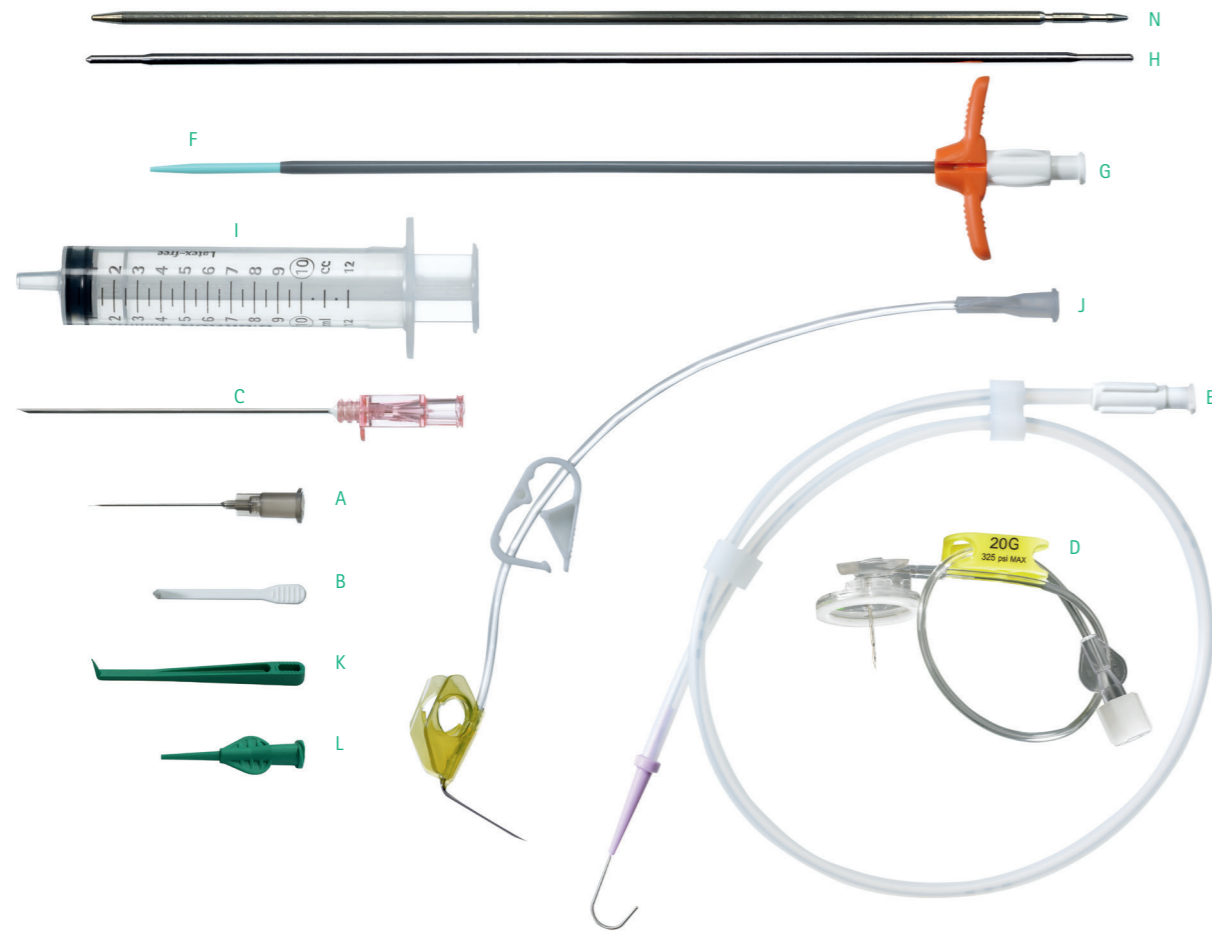

Accessories

Venous accessories							
Pieces	Implantation technique	Surgical Cut-down		Percutaneous			
		Kit 6	ECG	OTW	Seldinger		ECG
	Kit designation	Kit 6	Kit 14	Kit 10 (Brachial)	Kit 4 (Baby)	Kit 5 (Baby)	Kit 9
2	A Straight Surecan® needles	22 G x 30 mm	22 G x 30 mm	22 G x 30 mm	22 G x 30 mm	22 G x 30 mm	22 G x 30 mm
1	B Vein lifter	x	x	x	x	x	x
1	C Puncture needle			18 G x 70 mm	20 G x 50 mm	18 G x 70 mm	18 G x 70 mm
1	Introcan needle			20 G x 32 mm			
1	E J guide wire with dispenser		0.035" x 70 cm	0.035" x 150 cm	0.025" x 50 cm	0.035" x 50 cm	0.035" x 70 cm
1	F ECG cable		x				x
1	G Tear-away introducer/ Dilator			L 180/140 mm	L 80/50 mm	L 180/140 mm	180/140 mm
1	H Tunnelling rod			x	x	x	x
1	I Omnifix luer syringe		10 mL	10 mL	10 mL	10 mL	10 mL
1	J Winged Surecan® needle			22 G x 15 mm	22 G x 15 mm	22 G x 15 mm	20 G x 20 mm

Separate accessory kits					
Pieces	Reference	04430483	04430484	04430492	04430493
	Kit designation	AP 6F	AP 7F	AP 9F	AP 16F
1	C Puncture needle	20 G x 50 mm	18 G x 70 mm	18 G x 70 mm	18 G x 70 mm
1	Introcan needle	20 G x 32 mm			
1	E J guide wire with dispenser	0.025" x 50 cm	0.035" x 50 cm	0.035" x 50 cm	0.035" x 40 cm
1	G Tear-away introducer/ Dilator	6F, short (80/50 mm)	7F x180/140 mm	9F x180/140 mm	16F with dilator 12F-14F
1	H Tunnelling rod	x	x	x	x
1	B Vein lifter	x	x	x	
1	I Omnifix luer syringe	10 mL	10 mL	10 mL	10 mL
1	J Winged Surecan® needle	22 G x 15 mm	20 G x 20 mm	20 G x 20 mm	19 G x 25 mm

Accessories

Celsite® Safety accessory kits			
	Implantation technique	Seldinger	Surgical cut-down
	Kit Designation	Kit 7	Kit 8
A	Tunnelling Rod		-
B	Tear-away Introducer	L 180/ 140 mm	-
C	Omnifix® Luer Syringe	10 mL	-
D	Straight Surecan®	22 G x 30 mm	22 G x 30 mm
E	Vein Lifter		
F	Rinsing Hub		
G	Safecan™ Safety - Puncture Needle	18 G x 70 mm	-
H	Surecan® Safety II	20G x 20 mm	-
I	J Guide Wire with Dispenser	0.035" x 50 cm	-
J	Ultrasound Cover	-	-

Accessories

- A** Tunneling rod for easy catheter tunneling
- B** Peelable introducer sheath with dilatator for easy percutaneous access
- C** Omnifix® Luer Syringe
- D** 1 Surecan® Straight for flushing, aspiration and local anesthesia
- E** Long vein lifter allows easy handling
- F** Separate Rinsing Hub for more flushing flexibility during implantation
- G** Safecan™ Safety - Safety Echogenic Vein Puncture Needle
- H** Surecan® Safety II - Safety Port Needle
- I** Stainless Steel guidewire with flexible J-tip
- J** Ultrasound Cover

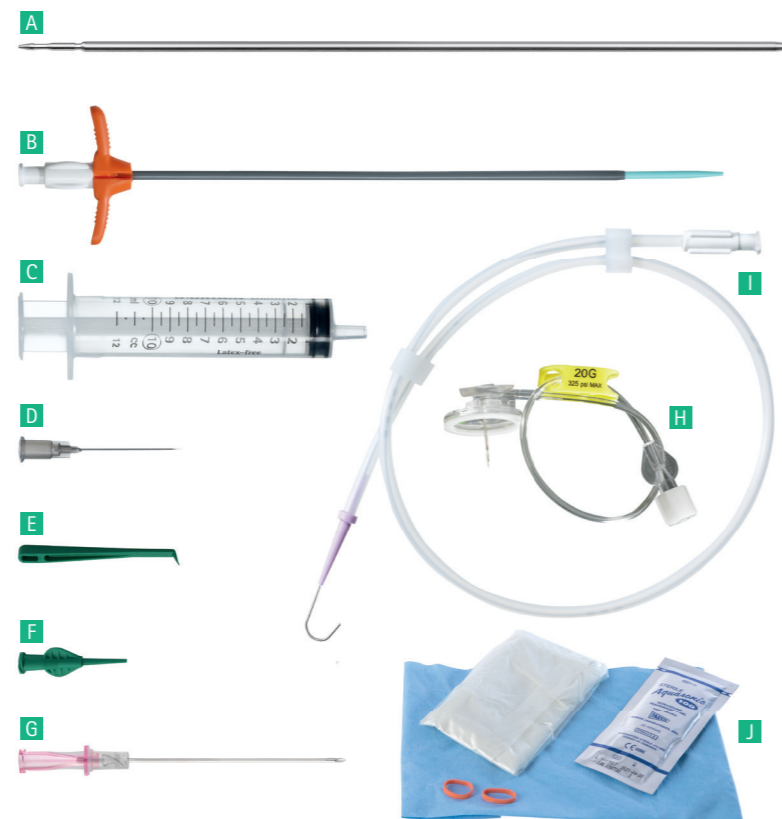

B. Braun Medical B.V. | +31 (0)412 67 24 11 | customer care.nl@bbraun.com | www.bb Braun.nl

The main product trademark 'Aesculap' is a registered trademark of Aesculap AG. The product trademarks „Celsite“, „Surecan“ and „Cytocan“ are registered trademarks of B. Braun Melsungen AG.
Subject to technical changes. All rights reserved. This brochure may only be used for the exclusive purpose of obtaining information about our products. Reproduction in any form partial or otherwise is not permitted.